

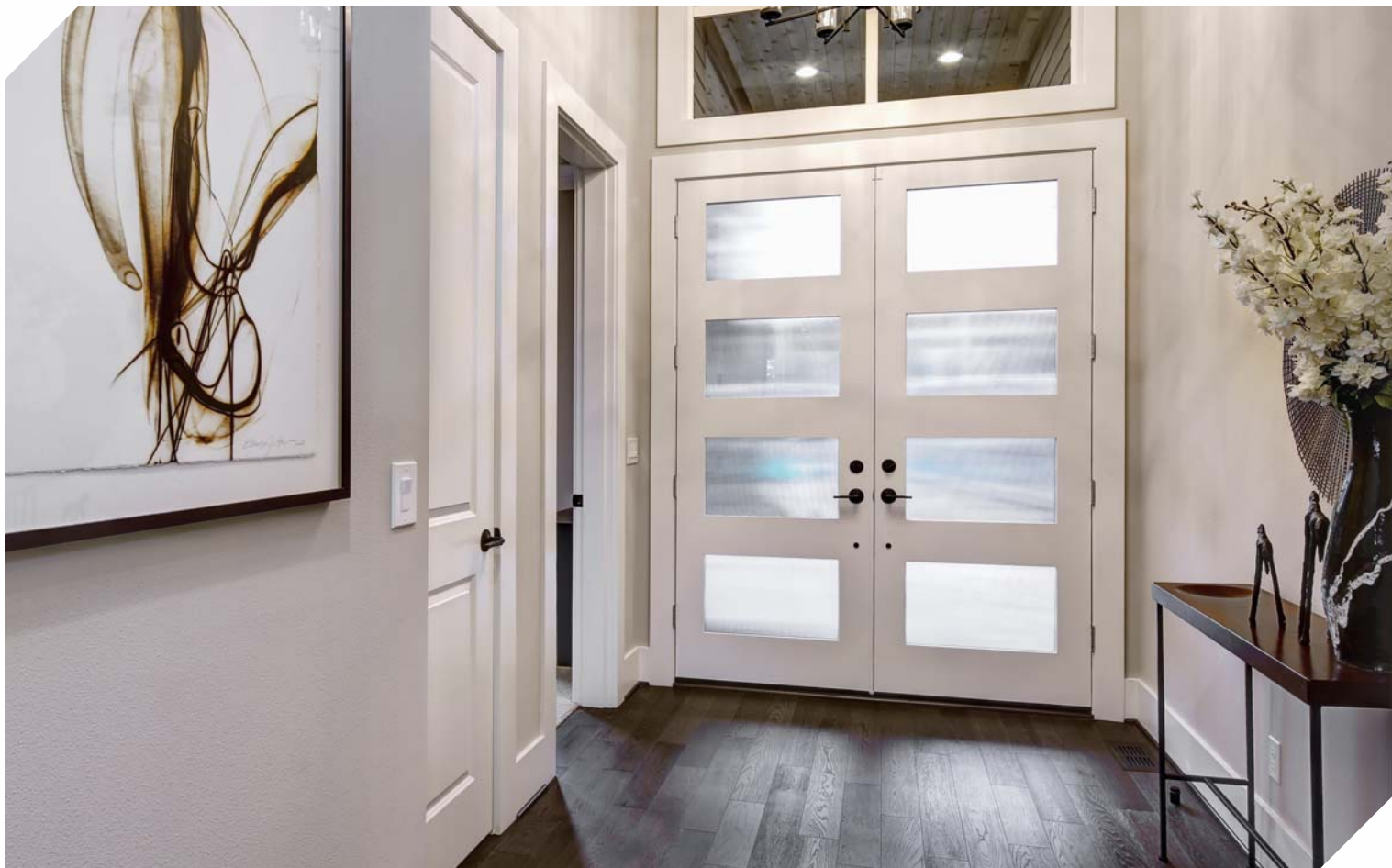

Scharnierprofile



***Ihr Lösungspartner für Aluminiumprofile mit seiner
hochmodernen Produktionsinfrastruktur.***

Scharnierprofile

Abmessungen Höhen Profil: 2500 mm - 2700 mm - 3000 mm

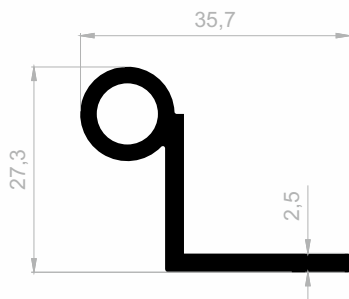

J 1943
SCHARNIERPROFILE
 GEWICHT : 0,477 kg/m

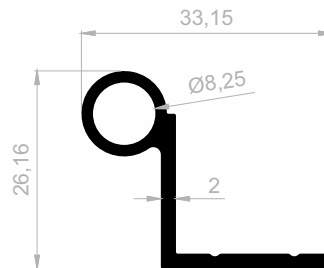

J 8393
SCHARNIERPROFILE
 GEWICHT : 0,347 kg/m

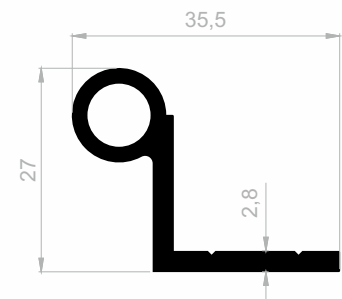

J 1141
SCHARNIERPROFILE
 GEWICHT : 0,494 kg/m

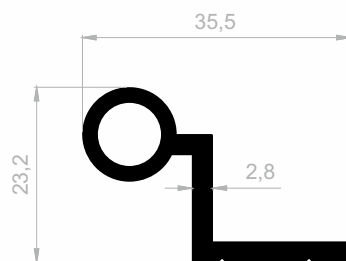

J 1140
SCHARNIERPROFILE
 GEWICHT : 0,465 kg/m

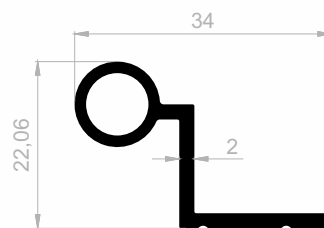

J 8394
SCHARNIERPROFILE
 GEWICHT : 0,327 kg/m

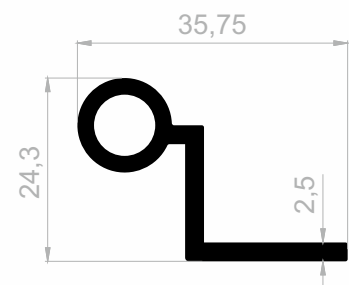

J 1942
SCHARNIERPROFILE
 GEWICHT : 0,455 kg/m

Scharnierprofile

Abmessungen Höhen Profil: 2500 mm - 2700 mm - 3000 mm

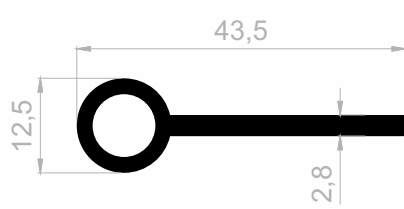

J 1284
SCHARNIERPROFILE
GEWICHT : 0,421 kg/m

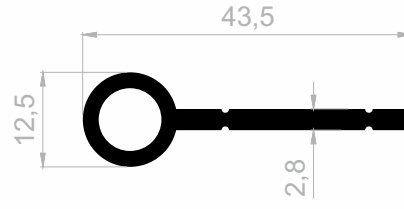

J 1957
SCHARNIERPROFILE
GEWICHT : 0,417 kg/m

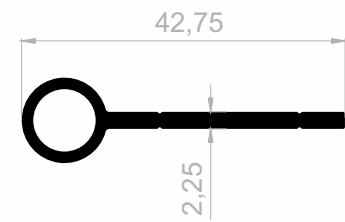

J 8395
SCHARNIERPROFILE
GEWICHT : 0,318 kg/m

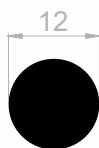

J 1055
SCHARNIERPROFILE
GEWICHT : 0,306 kg/m

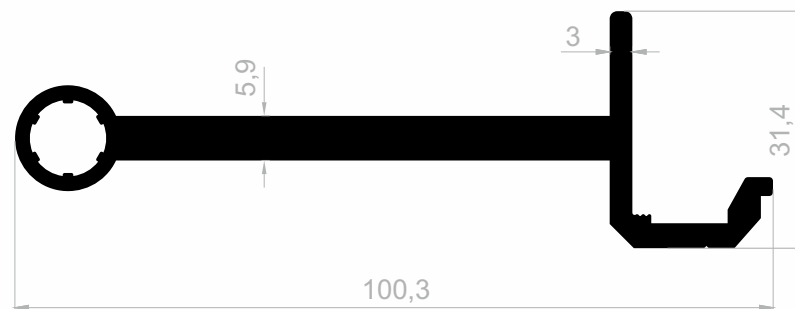

J 1619
SCHARNIERPROFILE
GEWICHT : 1,696 kg/m

Scharnierprofile

Abmessungen Höhen Profil: 2500 mm - 2700 mm - 3000 mm



J 1621
SCHARNIERPROFILE
GEWICHT : 1,499 kg/m

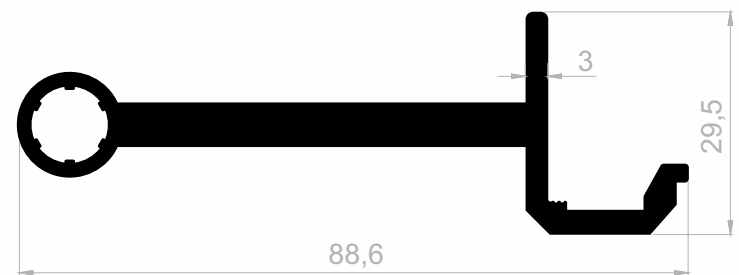

J 1622
SCHARNIERPROFILE
GEWICHT : 1,499 kg/m

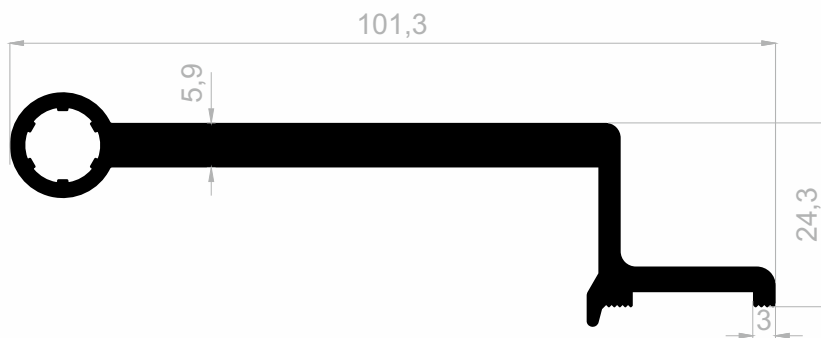

J 1620
SCHARNIERPROFILE
GEWICHT : 1,672 kg/m

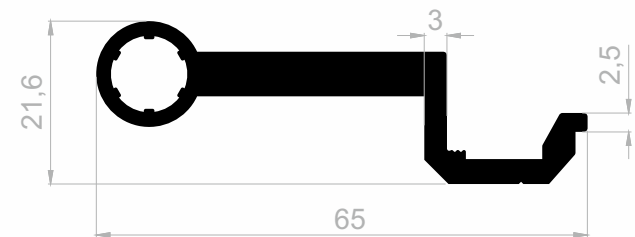

J 1623
SCHARNIERPROFILE
GEWICHT : 1,019 kg/m



Scharnierprofile

Abmessungen Höhen Profil: 2500 mm - 2700 mm - 3000 mm

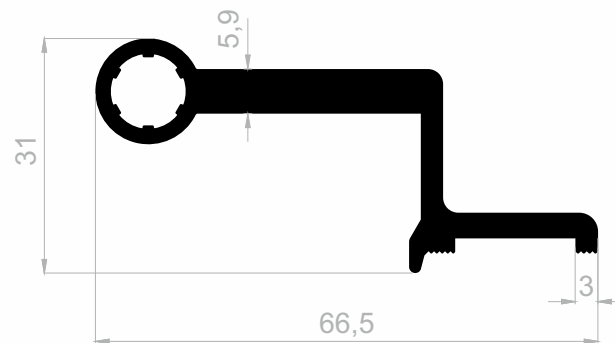

J 1624
SCHARNIERPROFILE
GEWICHT : 1,114 kg/m



J 1666
SCHARNIERPROFILE
GEWICHT : 0,696 kg/m



J 1667
SCHARNIERPROFILE
GEWICHT : 0,634 kg/m



Ihr Lösungspartner für Aluminiumprofile mit seiner hochmodernen Produktionsinfrastruktur.

Soziale Medien

Mit den Technologien, die wir ständig weiterentwickeln, Unsere Sozial-Medien-Konten, um über unsere Qualität und innovativen Aluminiumprofildesigns informiert zu sein Bitte folgen Sie.

   jutesanaluminyum

 JutesanAlmnm

 company/jutesan-alüminyum

 info@jutesanaluminyum.com.tr

 jutesanaluminyum.com.tr

