



Fensterbänke



***Ihr Lösungspartner für Aluminiumprofile mit seiner
hochmodernen Produktionsinfrastruktur.***

Fensterbänke

Abmessungen Höhen Profil: 2500 mm - 2700 mm - 3000 mm

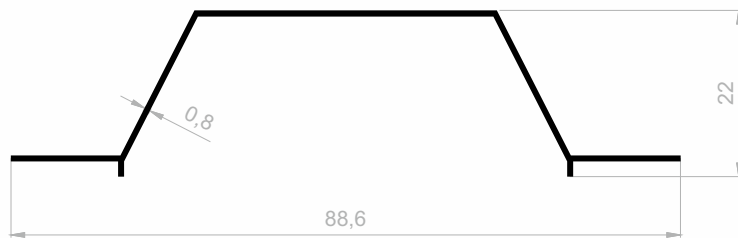

J 2101
FENSTERBÄNKE
GEWICHT : 0,252 kg/m

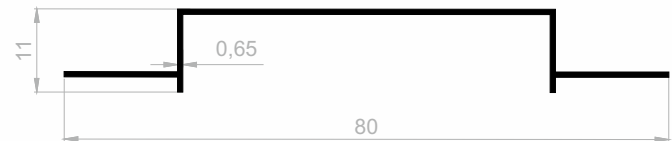

J 1932
FENSTERBÄNKE
GEWICHT : 0,190 kg/m

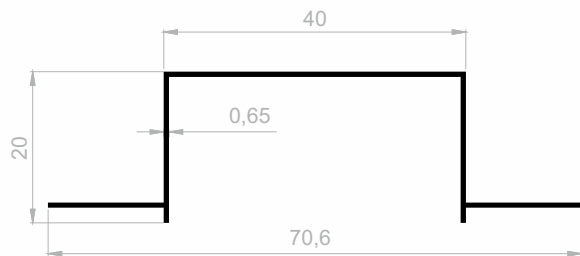

J 1936
FENSTERBÄNKE
GEWICHT : 0,206 kg/m

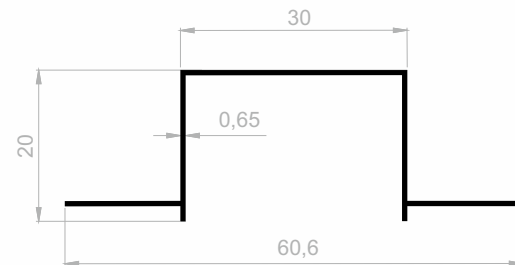

J 1937
FENSTERBÄNKE
GEWICHT : 0,187 kg/m

Fensterbänke

Abmessungen Höhen Profil: 2500 mm - 2700 mm - 3000 mm

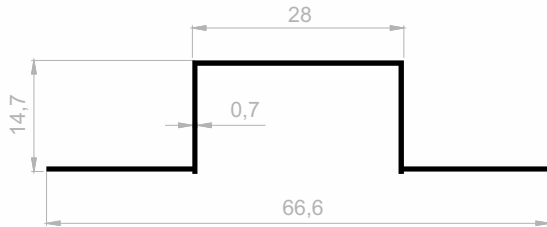

J 1938
FENSTERBÄNKE
GEWICHT : 0,168 kg/m

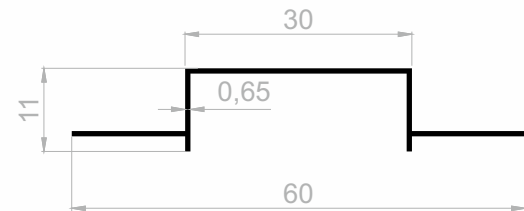

J 1939
FENSTERBÄNKE
GEWICHT : 0,152 kg/m

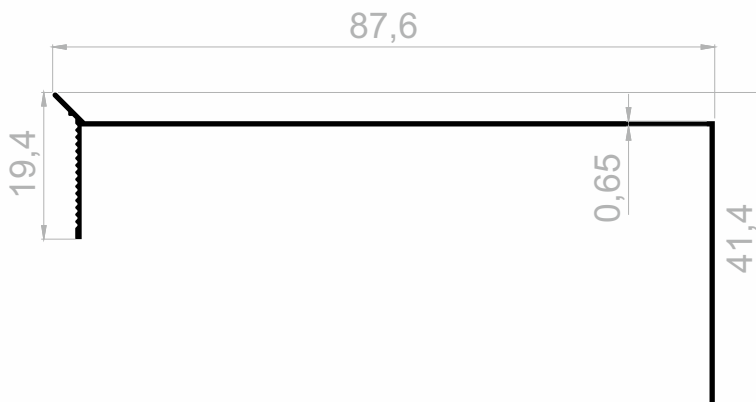

J 1934
FENSTERBÄNKE
GEWICHT : 0,268 kg/m

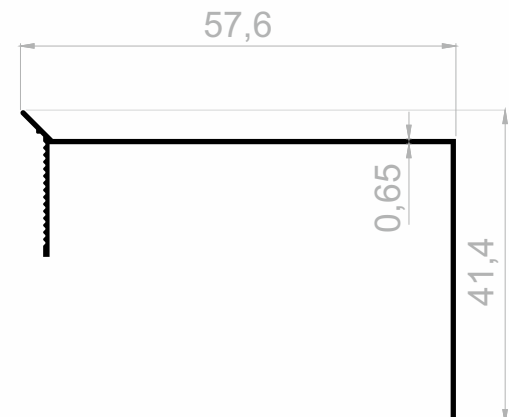

J 1928
FENSTERBÄNKE
GEWICHT : 0,211 kg/m

Fensterbänke

Abmessungen Höhen Profil: 2500 mm - 2700 mm - 3000 mm

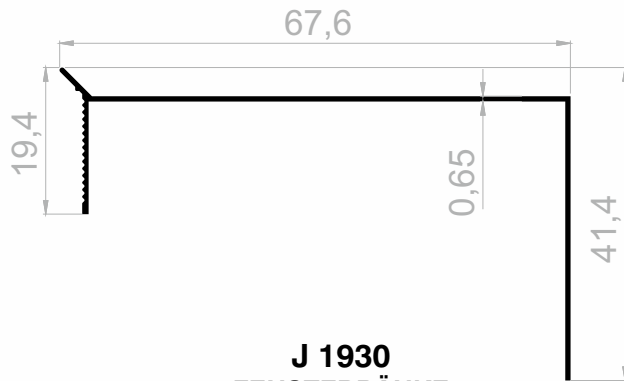

J 1930
FENSTERBÄNKE
GEWICHT : 0,230 kg/m

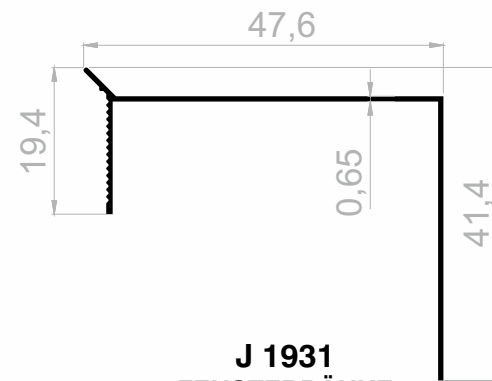

J 1931
FENSTERBÄNKE
GEWICHT : 0,192 kg/m

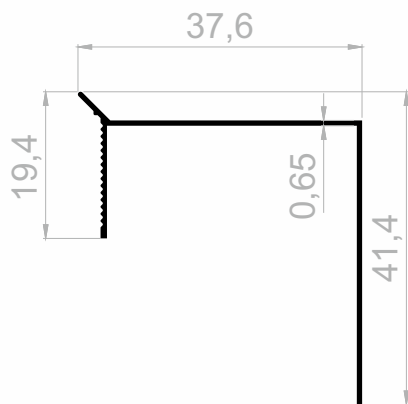

J 1935
FENSTERBÄNKE
GEWICHT : 0,173 kg/m

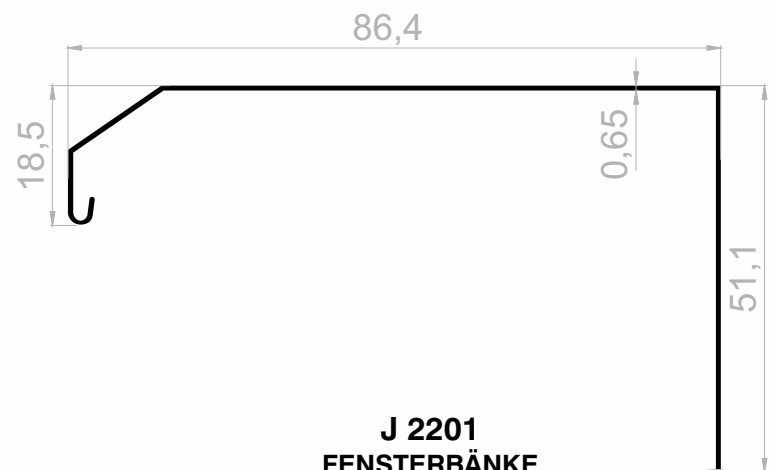

J 2201
FENSTERBÄNKE
GEWICHT : 0,274 kg/m

Fensterbänke

Abmessungen Höhen Profil: 2500 mm - 2700 mm - 3000 mm

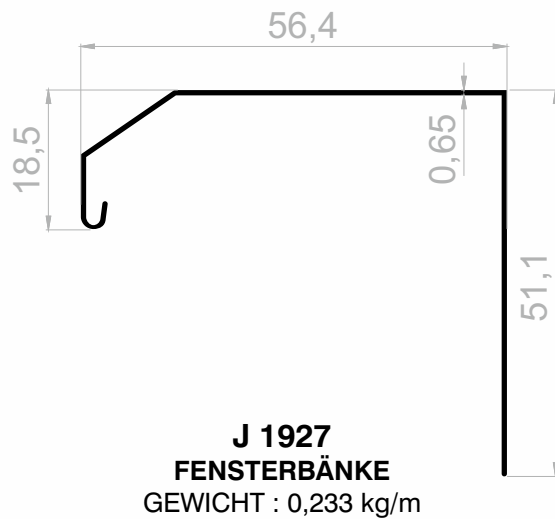
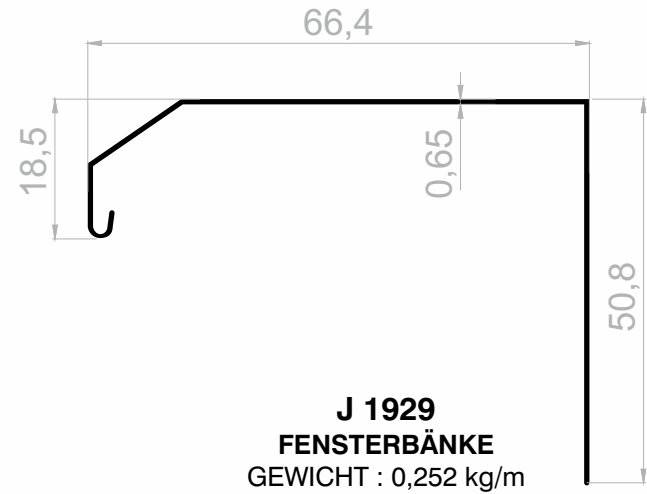
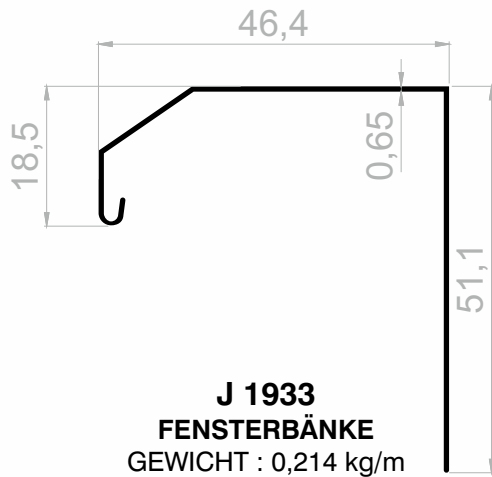



Fensterbänke

Abmessungen Höhen Profil: 2500 mm - 2700 mm - 3000 mm

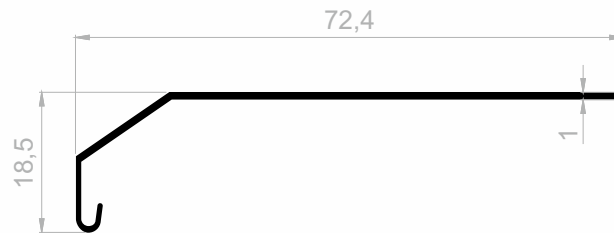

J 2114
FENSTERBÄNKE
GEWICHT : 0,230 kg/m

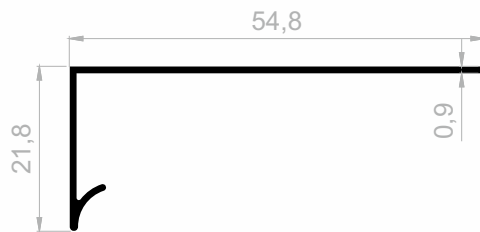

J 2465
FENSTERBÄNKE
GEWICHT : 0,198 kg/m

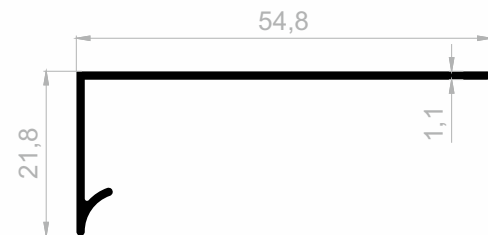

J 2200
FENSTERBÄNKE
GEWICHT : 0,238 kg/m



Ihr Lösungspartner für Aluminiumprofile mit seiner hochmodernen Produktionsinfrastruktur.

Soziale Medien

Mit den Technologien, die wir ständig weiterentwickeln, Unsere Sozial-Medien-Konten, um über unsere Qualität und innovativen Aluminiumprofildesigns informiert zu sein Bitte folgen Sie.

   jutesanaluminyum

 JutesanAlmnm

 company/jutesan-alüminyum

 info@jutesanaluminyum.com.tr

 jutesanaluminyum.com.tr

