



Schiebeprofille Serie



Ihr Lösungspartner für Aluminiumprofile mit seiner hochmodernen Produktionsinfrastruktur.

Schiebeprofile Serie

Abmessungen Höhen Profil: 4300 mm - 4600 mm - 4900 mm - 6000 mm

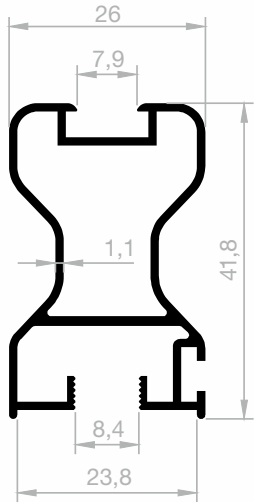

JM 1035
BREIT GRIFF
GEWICHT : 0,508 kg/m

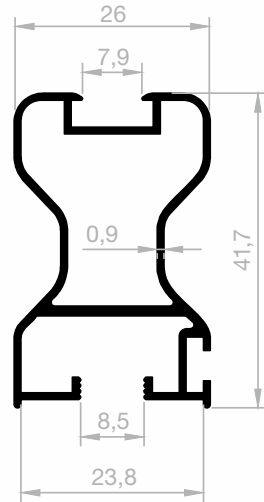

JM 6235
BREIT GRIFF
GEWICHT : 0,443 kg/m

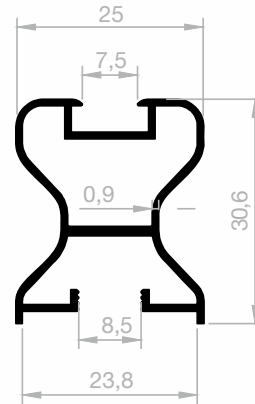

JM 6236
ECONOMIC GRIFF
GEWICHT : 0,340 kg/m

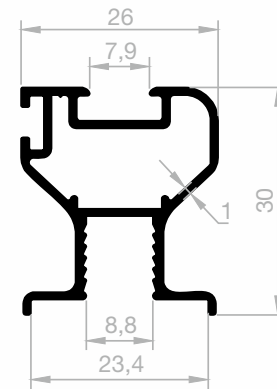

JM 1076
ECONOMIC GRIFF
GEWICHT : 0,365 kg/m

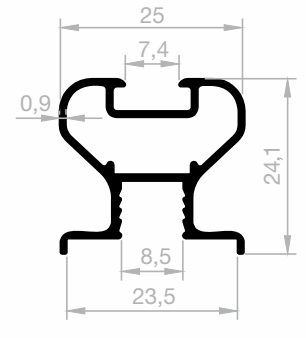

JM 6260
ECONOMIC GRIFF
GEWICHT : 0,295 kg/m

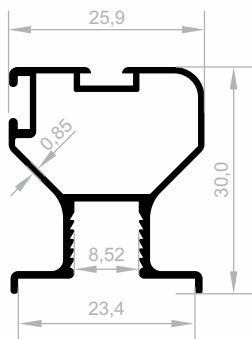

JM 1231
ECONOMIC GRIFF
GEWICHT : 0,335 kg/m

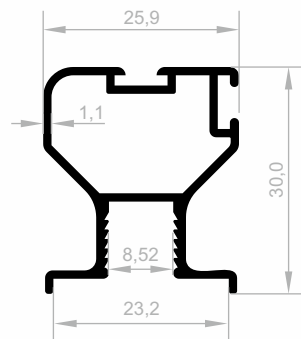

JM 1290
ECONOMIC GRIFF
GEWICHT : 0,394 kg/m

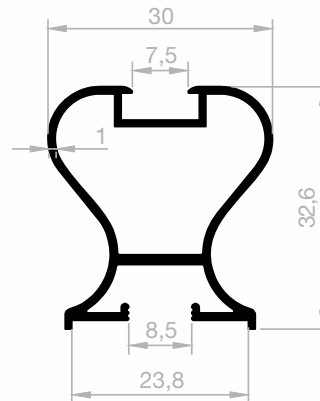

JM 6248
ECONOMIC GRIFF
GEWICHT : 0,379 kg/m

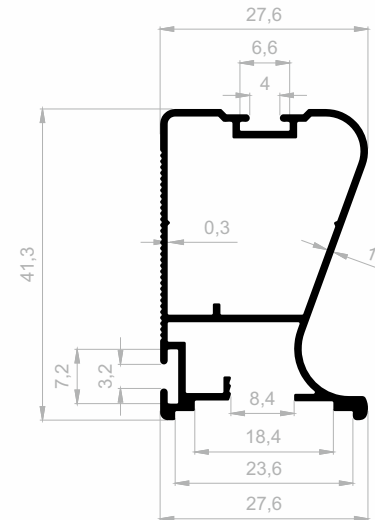

JM 10065
GRIFF
GEWICHT : 0,447 kg/m

Schiebepofile Serie

Abmessungen Höhen Profil: 4300 mm - 4600 mm - 4900 mm - 6000 mm

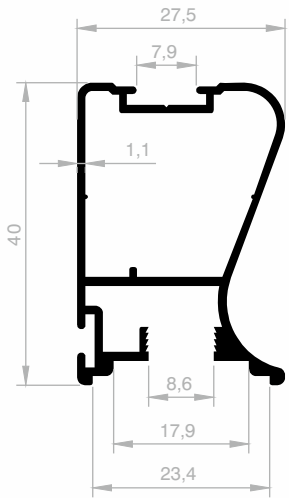

JM 3544
GRIFF

GEWICHT : 0,516 kg/m

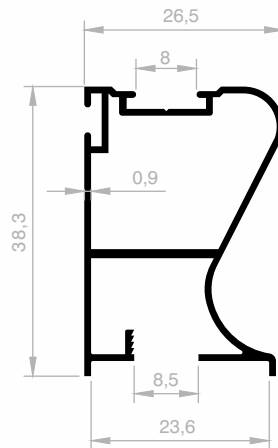

JM 6234
GRIFF

GEWICHT : 0,384 kg/m

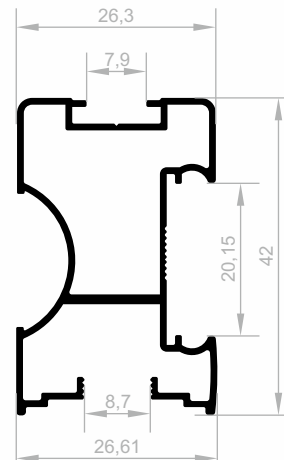

JM 8859
GRIFF

GEWICHT : 0,447 kg/m

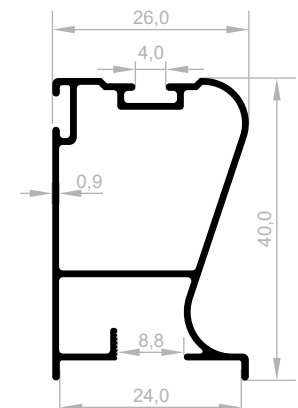

JM 1145
GRIFF

GEWICHT : 0,381 kg/m

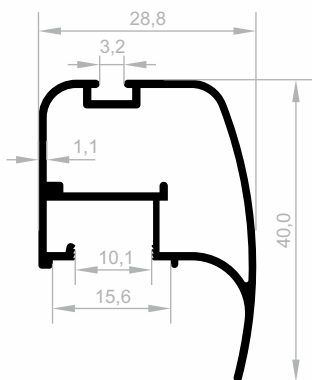

JM 1628
GRIFF

GEWICHT : 0,412 kg/m

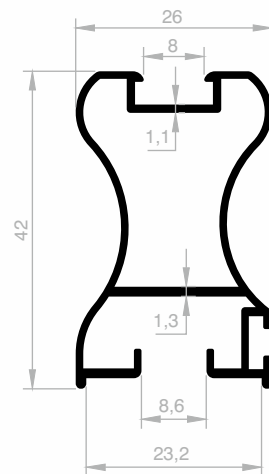

JM 2277
GRIFF

GEWICHT : 0,482 kg/m

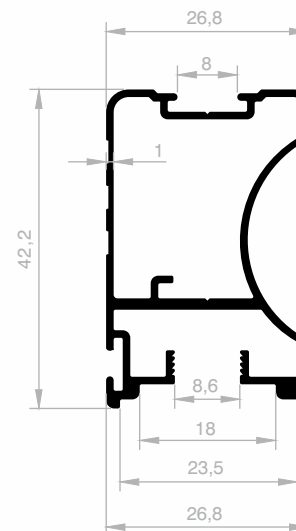

JM 5828
GRIFF

GEWICHT : 0,519 kg/m

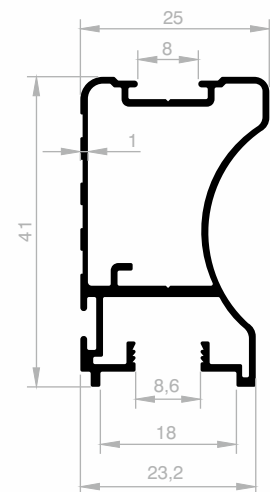

JM 6184
GRIFF

GEWICHT : 0,438 kg/m

Schiebeprofile Serie

Abmessungen Höhen Profil: 4300 mm - 4600 mm - 4900 mm - 6000 mm

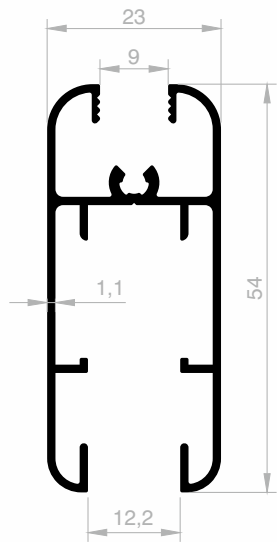

JM 3539
BODENVERBINDER
GEWICHT : 0,570 kg/m

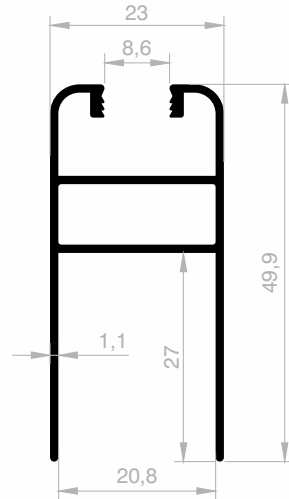

JM 1040
BODENVERBINDER
GEWICHT : 0,468 kg/m

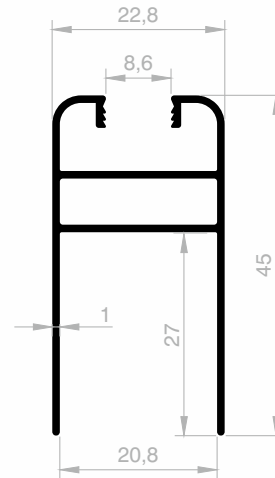

JM 6225
BODENVERBINDER
GEWICHT : 0,402 kg/m

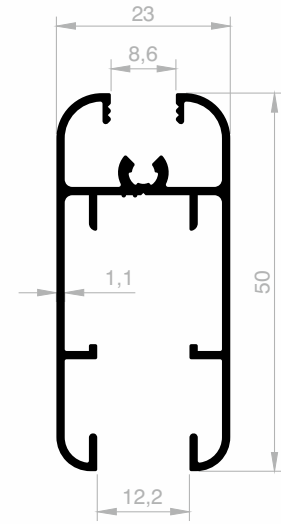

JM 6226
BODENVERBINDER
GEWICHT : 0,534 kg/m

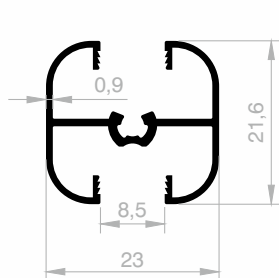

JM 6240
MITTENVERBINDER
GEWICHT : 0,249 kg/m

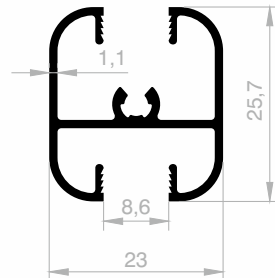

JM 1002
MITTENVERBINDER
GEWICHT : 0,335 kg/m

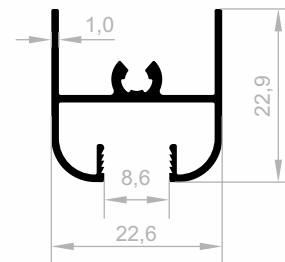

JM 1037
DECKENVERBINDER
GEWICHT : 0,259 kg/m

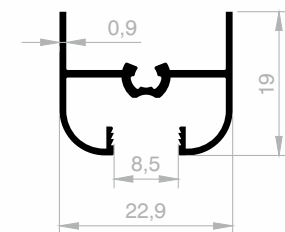

JM 6241
DECKENVERBINDER
GEWICHT : 0,205 kg/m

Schiebeprofile Serie

Abmessungen Höhen Profil: 4300 mm - 4600 mm - 4900 mm - 6000 mm

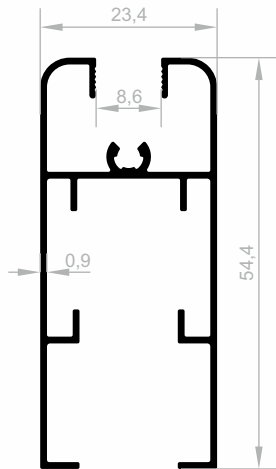

JM 8268
BODENVERBINDER
GEWICHT : 0,471 kg/m

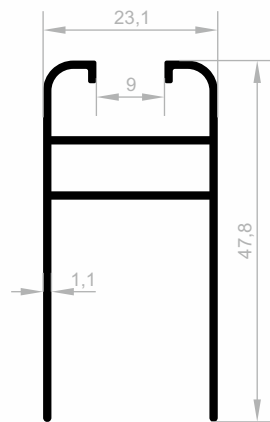

JM 1598
BODENVERBINDER
GEWICHT : 0,447 kg/m

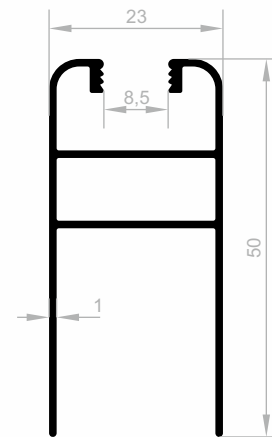

JM 1230
BODENVERBINDER
GEWICHT : 0,440 kg/m

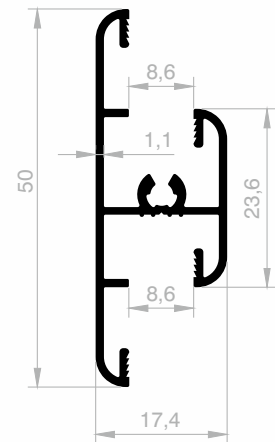

JM 4608
MITTENVERBINDER
GEWICHT : 0,354 kg/m

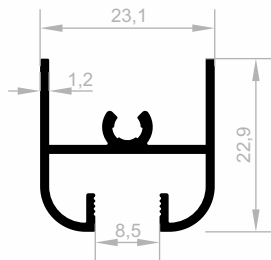

JM 1595
DECKENVERBINDER
GEWICHT : 0,306 kg/m

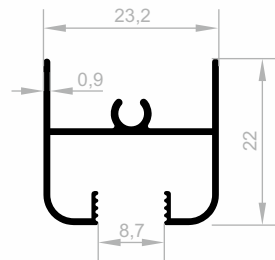

JM 1227
DECKENVERBINDER
GEWICHT : 0,216 kg/m

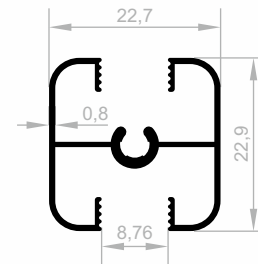

JM 10001
MITTENVERBINDER
GEWICHT : 0,241 kg/m

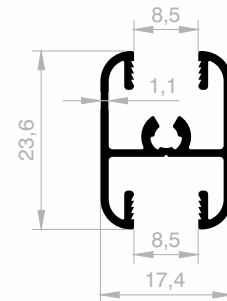

JM 4610
MITTENVERBINDER
GEWICHT : 0,270 kg/m

Schiebeprofile Serie

Abmessungen Höhen Profil: 4300 mm - 4600 mm - 4900 mm - 6000 mm

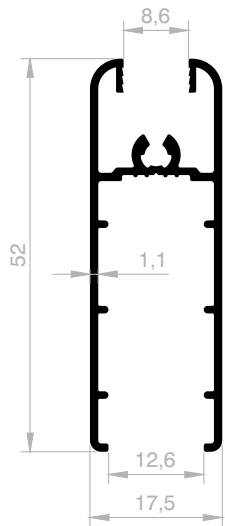

JM 4607
BODENVERBINDER
GEWICHT : 0,451 kg/m

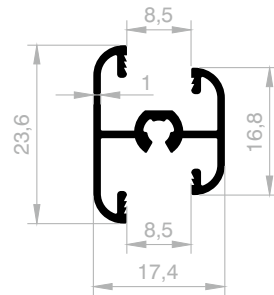

JM 6238
MITTENVERBINDER
GEWICHT : 0,243 kg/m

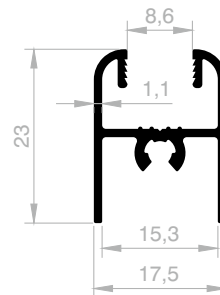

JM 4609
DECKENVERBINDER
GEWICHT : 0,265 kg/m

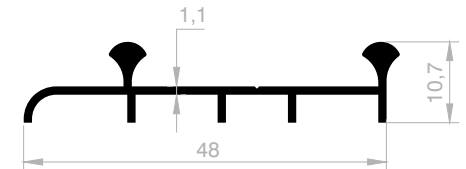

JM 1044
BODENSCHIENE
GEWICHT : 0,255 kg/m

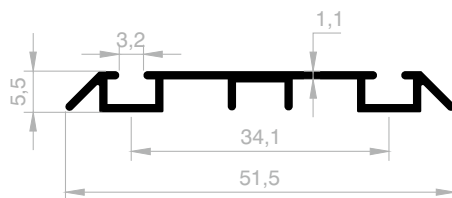

JM 1039
BODENSCHIENE
GEWICHT : 0,258 kg/m

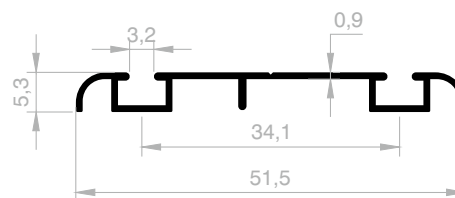

JM 6239
BODENSCHIENE
GEWICHT : 0,195 kg/m

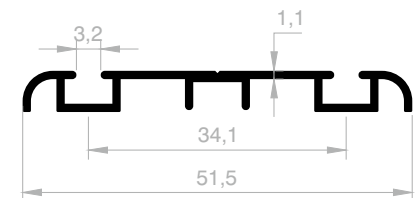

JM 3541
BODENSCHIENE
GEWICHT : 0,270 kg/m



Schiebeprofile Serie

Abmessungen Höhen Profil: 4300 mm - 4600 mm - 4900 mm - 6000 mm

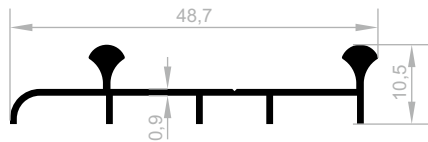

JM 1220
BODENSCHIENE
GEWICHT : 0,233 kg/m

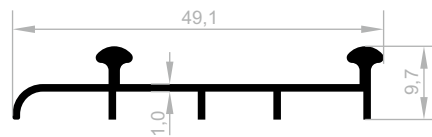

JM 1596
BODENSCHIENE
GEWICHT : 0,247 kg/m

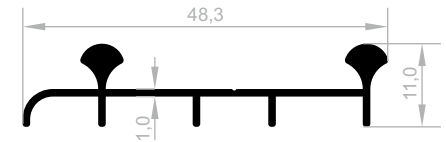

JM 1603
BODENSCHIENE
GEWICHT : 0,276 kg/m



JM 1577
BODENSCHIENE
GEWICHT : 0,206 kg/m



JM 1565
BODENSCHIENE
GEWICHT : 0,279 kg/m



JM 1567
BODENSCHIENE
GEWICHT : 0,290 kg/m

Schiebeprofile Serie

Abmessungen Höhen Profil: 4300 mm - 4600 mm - 4900 mm - 6000 mm

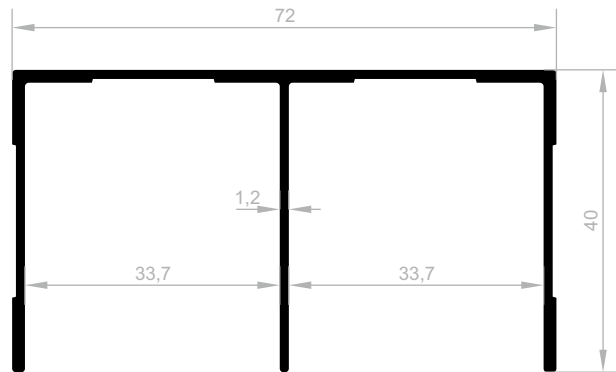

JM 1564
DECKENSCHIENE
GEWICHT : 0,710 kg/m

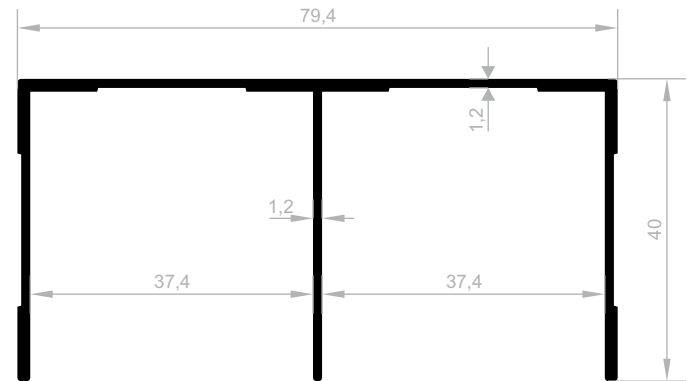

JM 1569
DECKENSCHIENE
GEWICHT : 0,734 kg/m

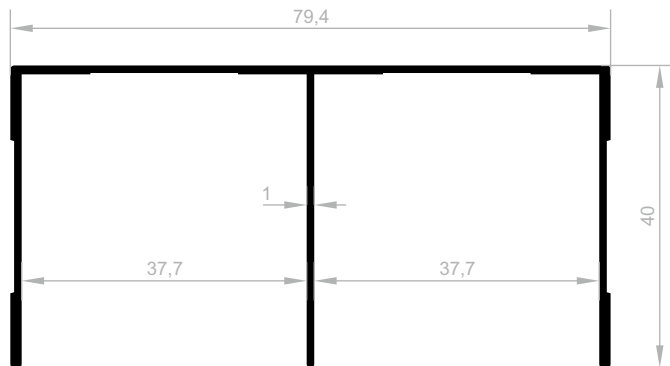

JM 1734
DECKENSCHIENE
GEWICHT : 0,599 kg/m

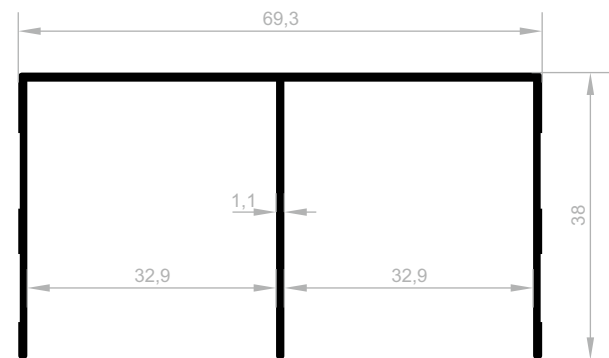

JM 1597
DECKENSCHIENE
GEWICHT : 0,553 kg/m

Schiebeprofile Serie

Abmessungen Höhen Profil: 4300 mm - 4600 mm - 4900 mm - 6000 mm

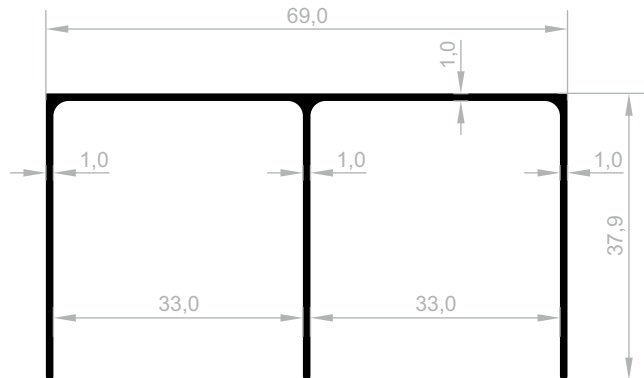

JM 1038
DECKENSCHIENE
GEWICHT : 0,496 kg/m

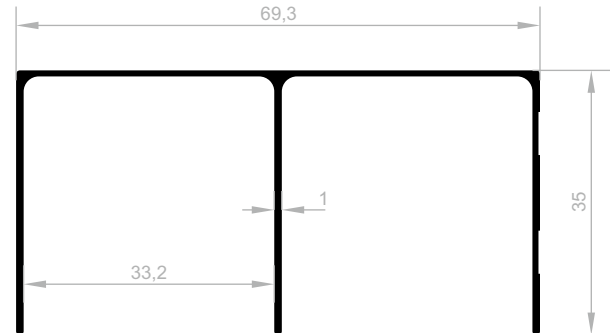

JM 1219-A
DECKENSCHIENE
GEWICHT : 0,429 kg/m

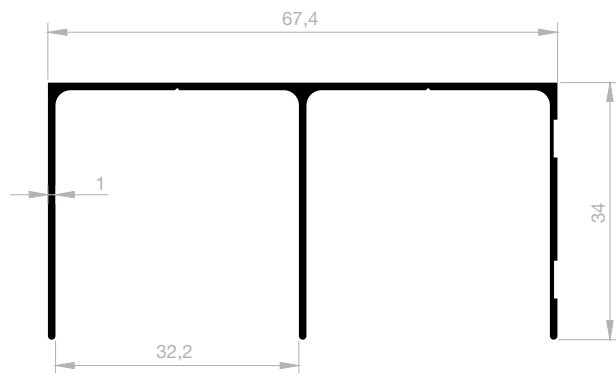

JM 5829
DECKENSCHIENE
GEWICHT : 0,447 kg/m

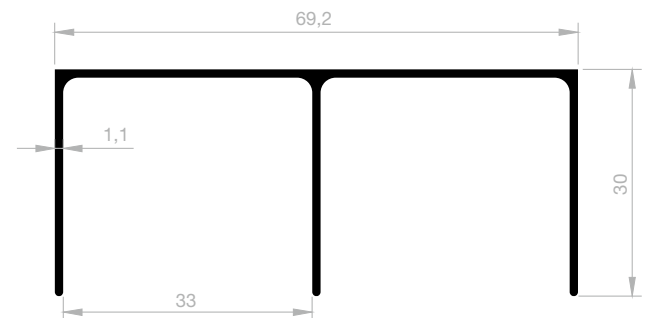

JM 1031
DECKENSCHIENE
GEWICHT : 0,472 kg/m

Schiebeprofile Serie

Abmessungen Höhen Profil: 4300 mm - 4600 mm - 4900 mm - 6000 mm

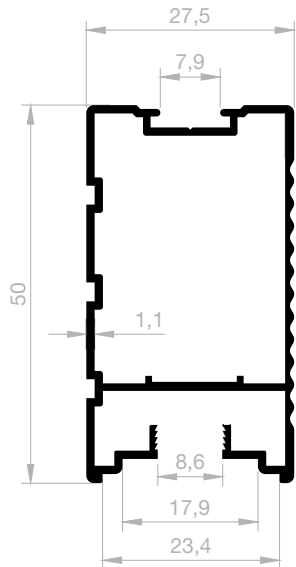

JM 3546
GRIFF

GEWICHT : 0,556 kg/m

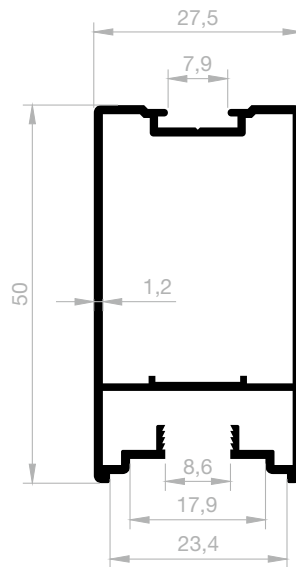

JM 3540
GRIFF

GEWICHT : 0,575 kg/m

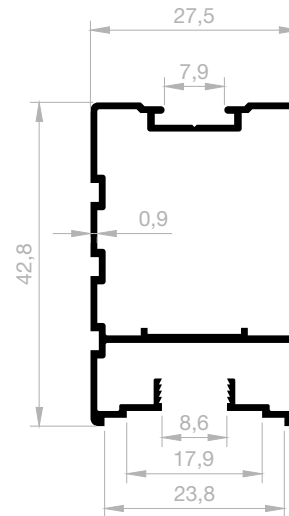

JM 6227
GRIFF

GEWICHT : 0,434 kg/m

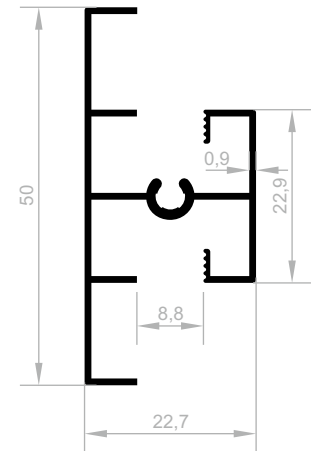

JM 1552
MITTENVERBINDER
GEWICHT : 0,360 kg/m

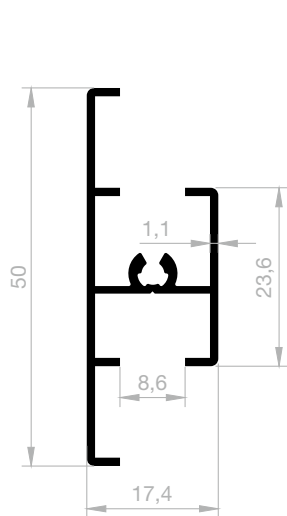

JM 3543
MITTENVERBINDER
GEWICHT : 0,355 kg/m

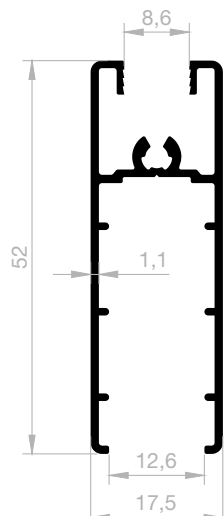

JM 3542
BODENVERBINDER
GEWICHT : 0,454 kg/m

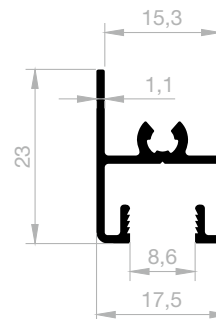

JM 3545
DECKENVERBINDER
GEWICHT : 0,265 kg/m

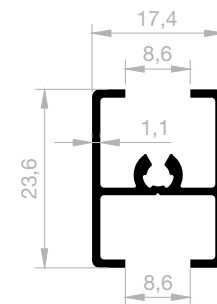

JM 4325
MITTENVERBINDER
GEWICHT : 0,256 kg/m

Schiebepofile Serie

Abmessungen Höhen Profil: 4300 mm - 4600 mm - 4900 mm - 6000 mm

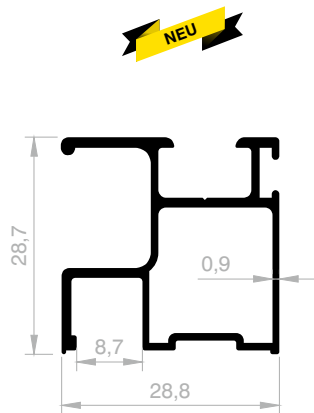

JM 1588
SEITLICHER GRIFF STANDARD
GEWICHT : 0,420 kg/m

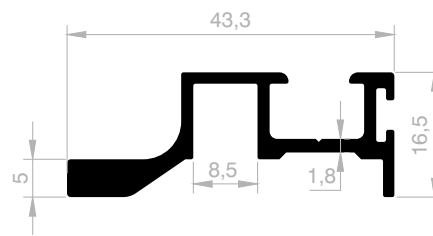

JM 4554
BREITSEITIGER GRIFF
GEWICHT : 0,504 kg/m

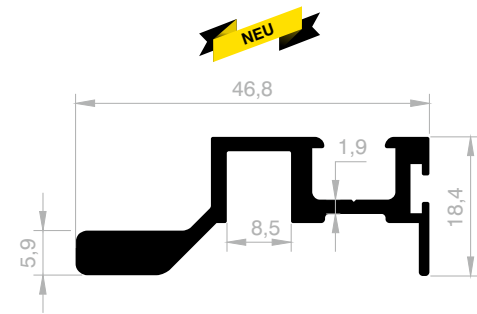

JM 1587
BREITSEITIGER GRIFF
GEWICHT : 0,610 kg/m

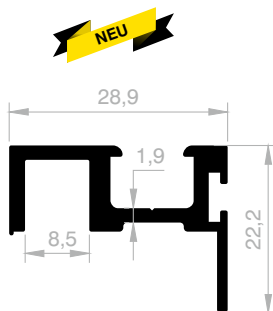

JM 1586
CHMALSEITIGER GRIFF
GEWICHT : 0,417 kg/m

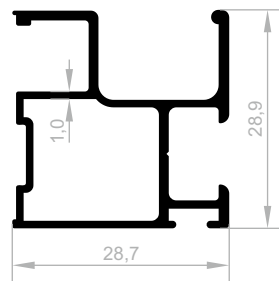

JM 1975
SEITLICHER GRIFF STANDARD
GEWICHT : 0,420 kg/m

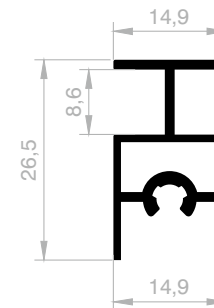

JM 1585
MITTENVERBINDER
GEWICHT : 0,308 kg/m

Schiebepofile Serie

Abmessungen Höhen Profil: 4300 mm - 4600 mm - 4900 mm - 6000 mm

NEU

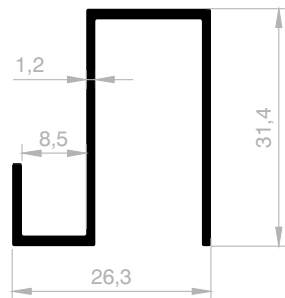

JM 1584
OBERE / UNTERE VERBINDER
GEWICHT : 0,334 kg/m

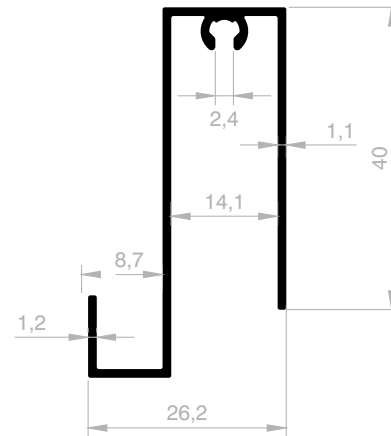

JM 4555
OBERE / UNTERE VERBINDER
GEWICHT : 0,419 kg/m

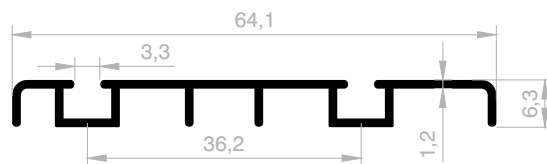

JM 3877
BODENSCHIENE
GEWICHT : 0,338 kg/m

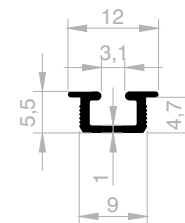

JM 1583
EINGebaUTE BODEN/DECKENSCHIENE
GEWICHT : 0,073 kg/m



Ihr Lösungspartner für Aluminiumprofile mit seiner hochmodernen Produktionsinfrastruktur.

Soziale Medien

Mit den Technologien, die wir ständig weiterentwickeln, Unsere Sozial-Medien-Konten, um über unsere Qualität und innovativen Aluminiumprofildesigns informiert zu sein Bitte folgen Sie.

   jutesanaluminyum

 JutesanAlmnm

 company/jutesan-alüminyum

 info@jutesanaluminyum.com.tr

 jutesanaluminyum.com.tr

