



Rahmen Abdeckung Profile



***Ihr Lösungspartner für Aluminiumprofile mit seiner
hochmodernen Produktionsinfrastruktur.***

Rahmen Abdeckung Profile

Abmessungen Höhen Profil: 2500 mm - 3000 mm - 5000 mm - 6000 mm

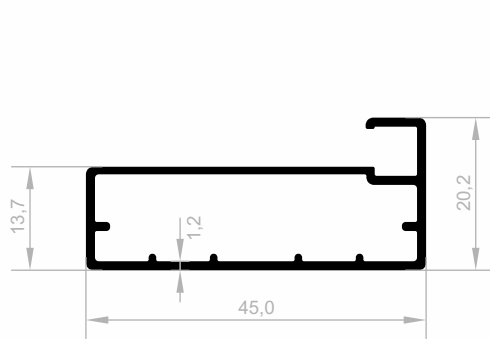

JM 6171
RAHMEN ABDECKUNG
 GEWICHT : 0,417 kg/m

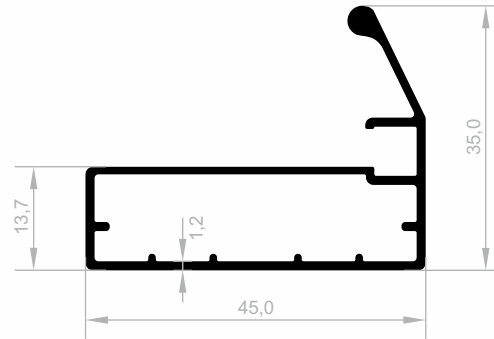

JM 6172
RAHMEN ABDECKUNG
 GEWICHT : 0,496 kg/m

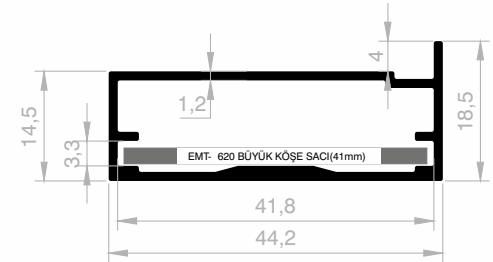

JM 4613
RAHMEN ABDECKUNG
 GEWICHT : 0,443 kg/m

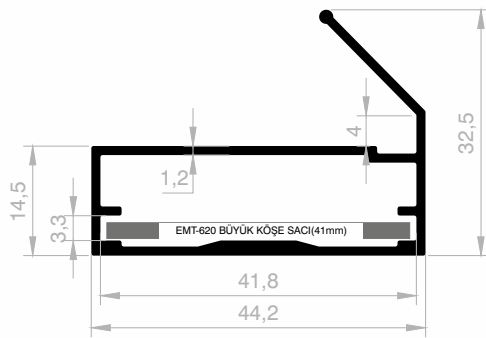

JM 4612
RAHMEN ABDECKUNG
 GEWICHT : 0,507 kg/m

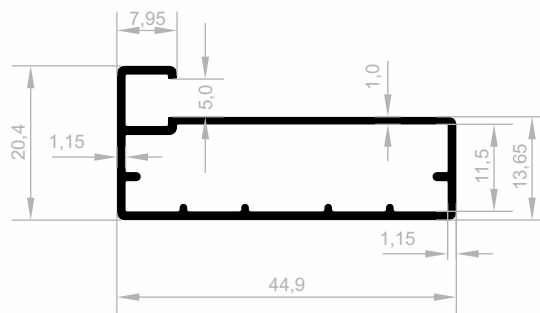

JM 11012
RAHMEN ABDECKUNG
 GEWICHT : 0,404 kg/m

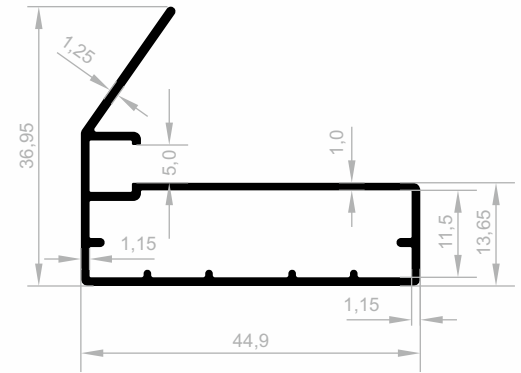

JM 11011
RAHMEN ABDECKUNG
 GEWICHT : 0,472 kg/m

Rahmen Abdeckung Profile

Abmessungen Höhen Profil: 2500 mm - 3000 mm - 5000 mm - 6000 mm

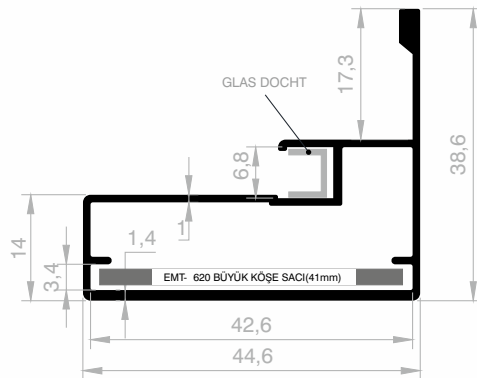

JM 4307
RAHMEN ABDECKUNG
 GEWICHT : 0,536 kg/m

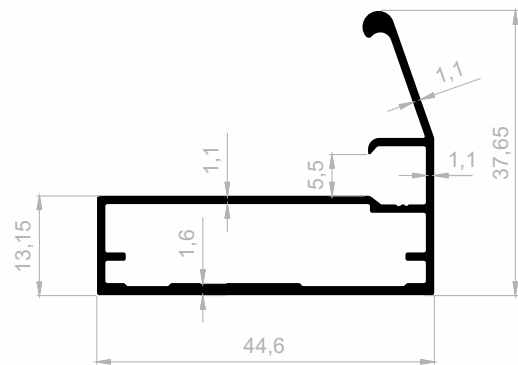

JM 10070
RAHMEN ABDECKUNG
 GEWICHT : 0,507 kg/m

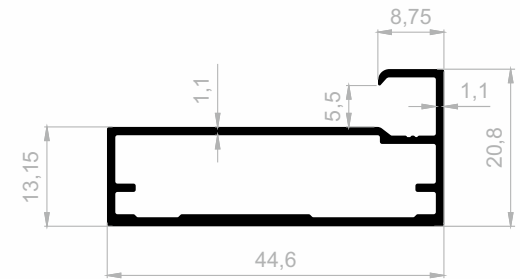

JM 10071
RAHMEN ABDECKUNG
 GEWICHT : 0,432 kg/m

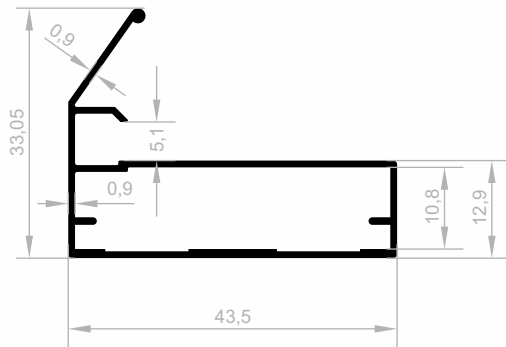

JM 10034
RAHMEN ABDECKUNG
 GEWICHT : 0,377 kg/m

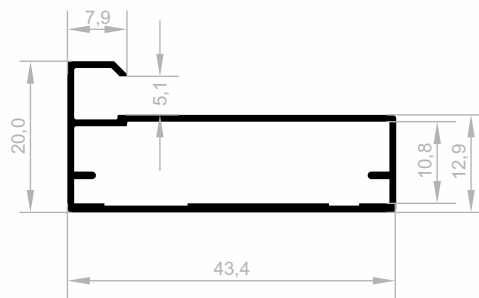

JM 10033
RAHMEN ABDECKUNG
 GEWICHT : 0,339 kg/m

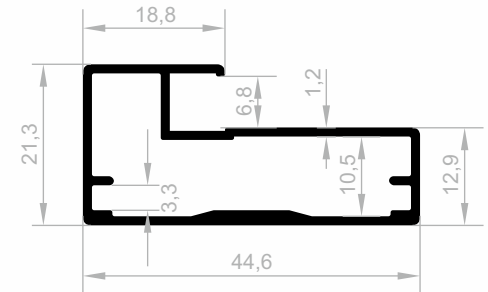

JM 10066
RAHMEN ABDECKUNG
 GEWICHT : 0,496 kg/m

Rahmen Abdeckung Profile

Abmessungen Höhen Profil: 2500 mm - 3000 mm - 5000 mm - 6000 mm

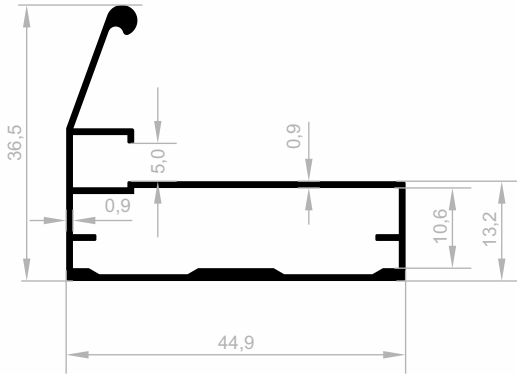

JM 10019
RAHMEN ABDECKUNG
GEWICHT : 0,434 kg/m

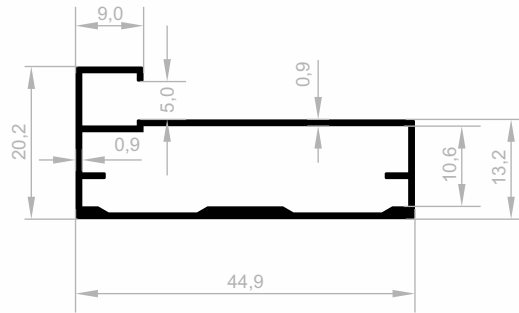

JM 10020
RAHMEN ABDECKUNG
GEWICHT : 0,367 kg/m

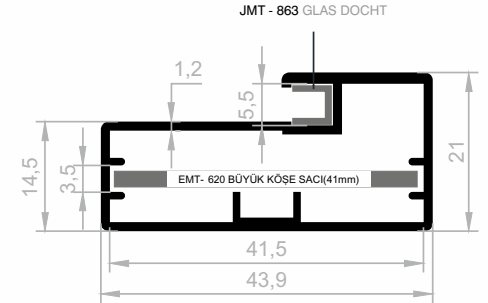

JM 3528
RAHMEN ABDECKUNG
GEWICHT : 0,495 kg/m

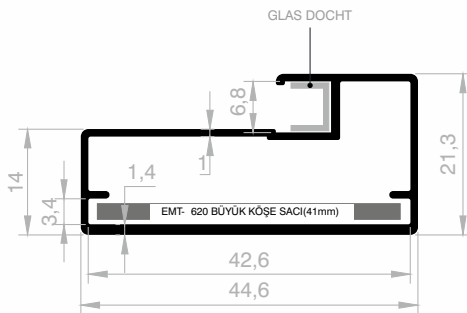

JM 4311
RAHMEN ABDECKUNG
GEWICHT : 0,459 kg/m

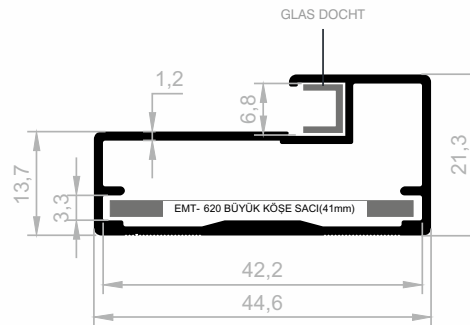

JM 4848
RAHMEN ABDECKUNG
GEWICHT : 0,493 kg/m

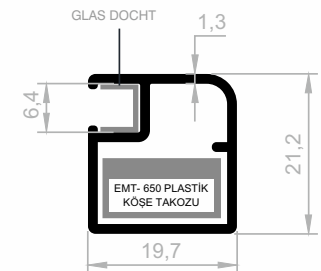

JM 1094
RAHMEN ABDECKUNG
GEWICHT : 0,280 kg/m

Rahmen Abdeckung Profile

Abmessungen Höhen Profil: 2500 mm - 3000 mm - 5000 mm - 6000 mm

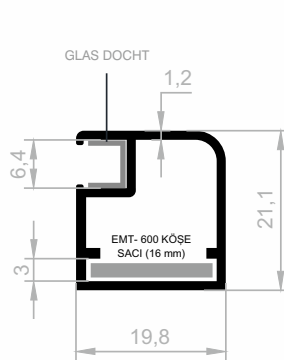

JM 1157
RAHMEN ABDECKUNG
 GEWICHT : 0,270 kg/m

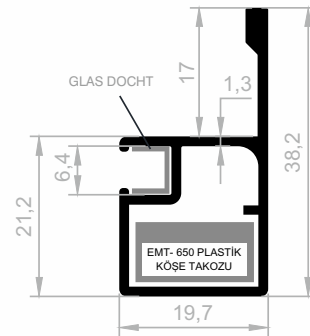

JM 4648
RAHMEN ABDECKUNG
 GEWICHT : 0,403 kg/m

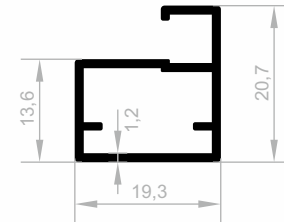

JM 2006
RAHMEN ABDECKUNG
 GEWICHT : 0,263 kg/m

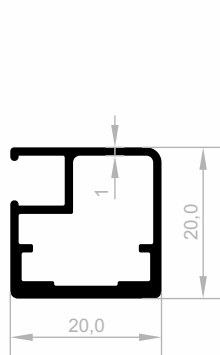

JM 3385
RAHMEN ABDECKUNG
 GEWICHT : 0,312 kg/m

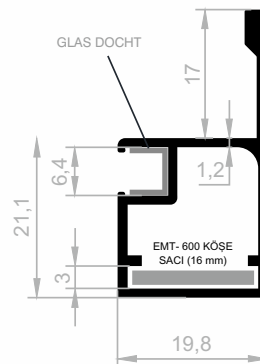

JM 4649
RAHMEN ABDECKUNG
 GEWICHT : 0,383 kg/m

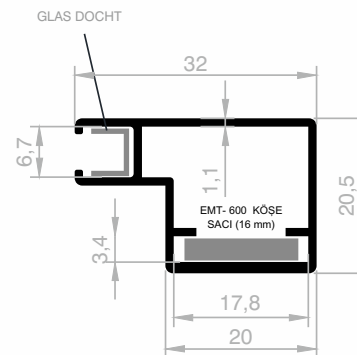

JM 4752
RAHMEN ABDECKUNG
 GEWICHT : 0,346 kg/m

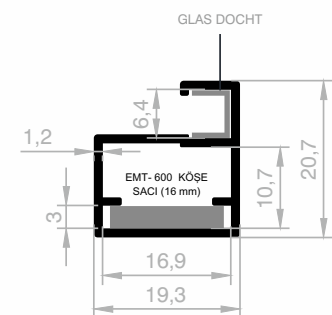

JM 3931
RAHMEN ABDECKUNG
 GEWICHT : 0,267 kg/m

Rahmen Abdeckung Profile

Abmessungen Höhen Profil: 2500 mm - 3000 mm - 5000 mm - 6000 mm

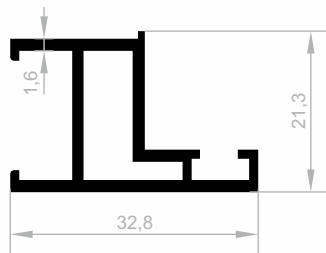

JM 1777
RAHMEN ABDECKUNG
 GEWICHT : 0,418 kg/m

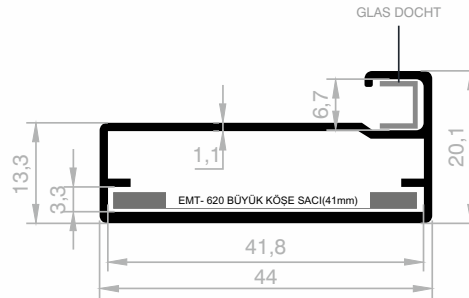

JM 1212
RAHMEN ABDECKUNG
 GEWICHT : 0,437 kg/m

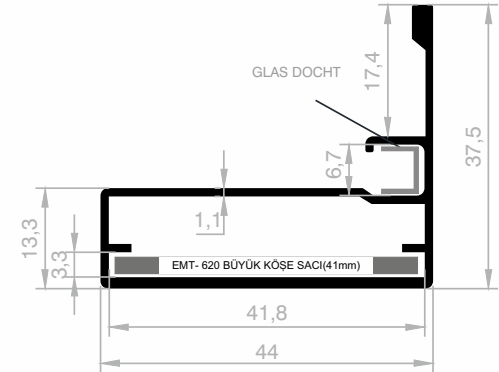

JM 4646
RAHMEN ABDECKUNG
 GEWICHT : 0,516 kg/m

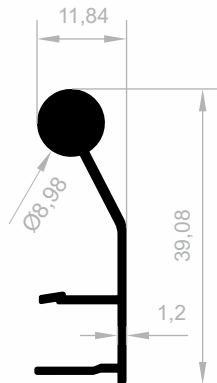

JM 2005
RAHMEN ABDECKUNG
 GEWICHT : 0,347 kg/m

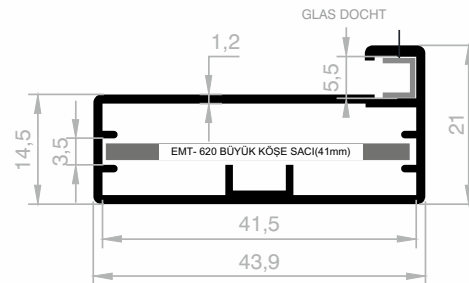

JM 3527
RAHMEN ABDECKUNG
 GEWICHT : 0,467 kg/m

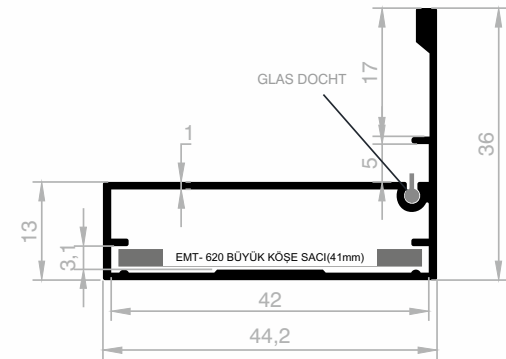

JM 4647
RAHMEN ABDECKUNG
 GEWICHT : 0,450 kg/m



Ihr Lösungspartner für Aluminiumprofile mit seiner hochmodernen Produktionsinfrastruktur.

Soziale Medien

Mit den Technologien, die wir ständig weiterentwickeln, Unsere Sozial-Medien-Konten, um über unsere Qualität und innovativen Aluminiumprofildesigns informiert zu sein Bitte folgen Sie.

   jutesanaluminyum

 JutesanAlmnm

 company/jutesan-alüminyum

 info@jutesanaluminyum.com.tr

 jutesanaluminyum.com.tr

