



## *Aluminium Schiebesystem Profile*



***Ihr Lösungspartner für Aluminiumprofile mit seiner hochmodernen Produktionsinfrastruktur.***



## Aluminium Schiebesystem Profile

Abmessungen Höhen Profil: 2500 mm - 3000 mm - 5000 mm - 6000 mm

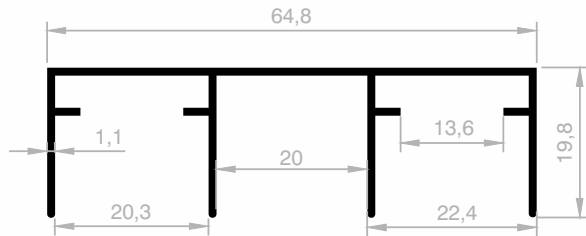

**JM 4030**  
**DECKENSCHIENE**  
GEWICHT : 0,440 kg/m

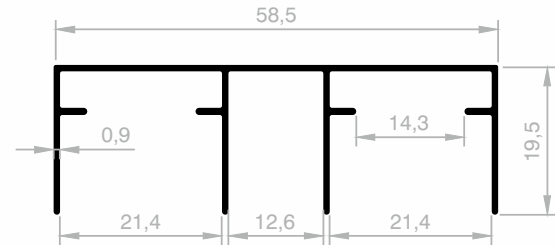

**JM 4903**  
**DECKENSCHIENE**  
GEWICHT : 0,345 kg/m

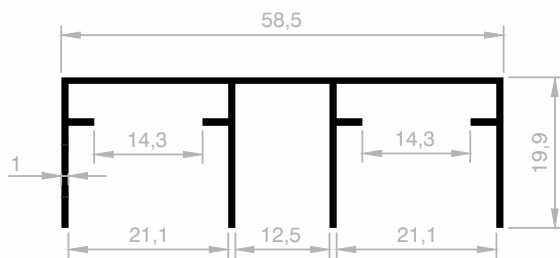

**JM 6213**  
**DECKENSCHIENE**  
GEWICHT : 0,367 kg/m

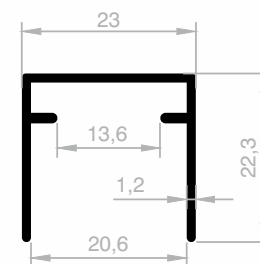

**JM 2064**  
**DECKENSCHIENE**  
GEWICHT : 0,230 kg/m



## Aluminium Schiebesystem Profile

Abmessungen Höhen Profil: 2500 mm - 3000 mm - 5000 mm - 6000 mm

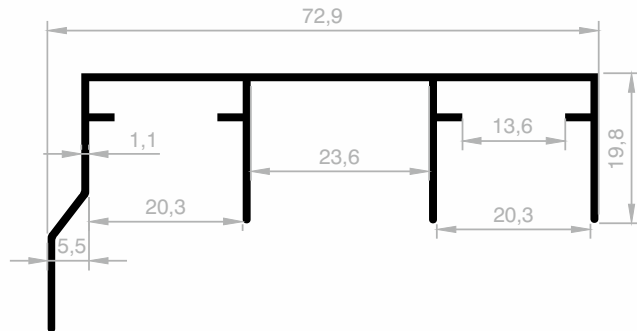

**JM 4031**  
DECKENSCHIENE  
GEWICHT : 0,491 kg/m

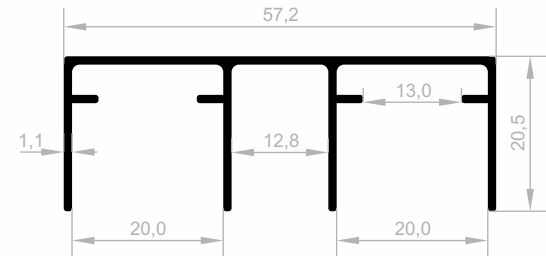

**JM 1604**  
DECKENSCHIENE  
GEWICHT : 0,445 kg/m

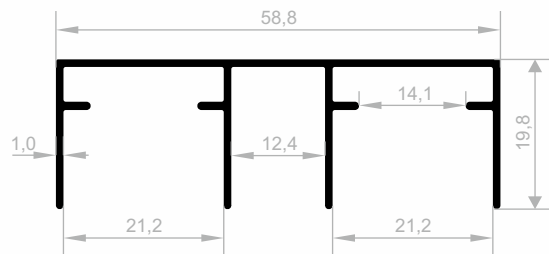

**JM 1711**  
DECKENSCHIENE  
GEWICHT : 0,404 kg/m

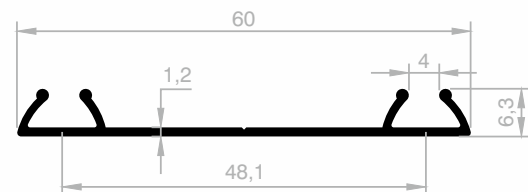

**JM 1611**  
BODENSCHIENE  
GEWICHT : 0,245 kg/m

## Aluminium Schiebesystem Profile

Abmessungen Höhen Profil: 2500 mm - 3000 mm - 5000 mm - 6000 mm

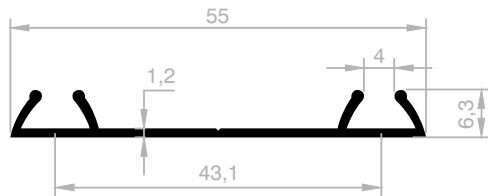

**JM 1731**  
**BODENSCHIENE**  
 GEWICHT : 0,225 kg/m

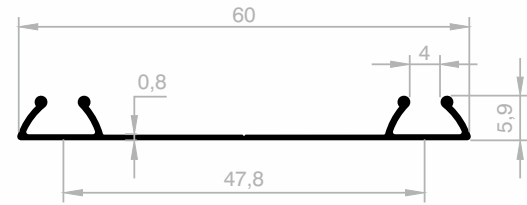

**JM 4897**  
**BODENSCHIENE**  
 GEWICHT : 0,189 kg/m

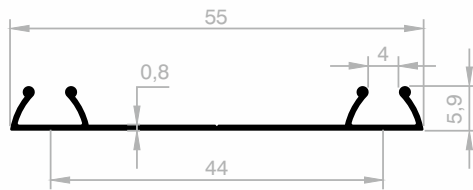

**JM 4898**  
**BODENSCHIENE**  
 GEWICHT : 0,175 kg/m

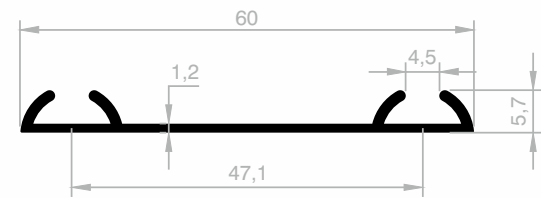

**JM 1195**  
**BODENSCHIENE**  
 GEWICHT : 0,265 kg/m

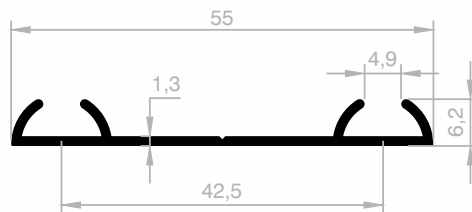

**JM 4095**  
**BODENSCHIENE**  
 GEWICHT : 0,280 kg/m

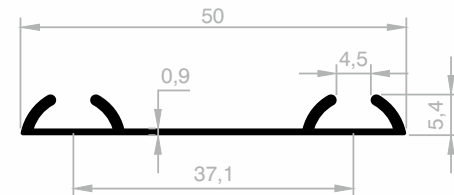

**JM 4029**  
**BODENSCHIENE**  
 GEWICHT : 0,230 kg/m

## Aluminium Schiebesystem Profile

Abmessungen Höhen Profil: 2500 mm - 3000 mm - 5000 mm - 6000 mm

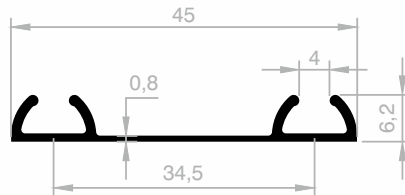

**JM 5941**  
**BODENSCHIENE**  
GEWICHT : 0,200 kg/m

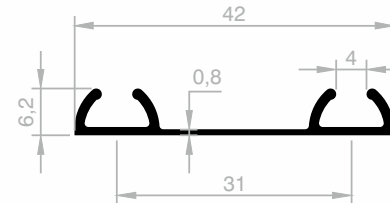

**JM 5940**  
**BODENSCHIENE**  
GEWICHT : 0,193 kg/m

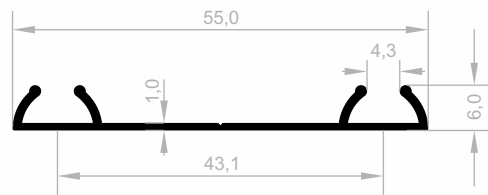

**JM 1605**  
**BODENSCHIENE**  
GEWICHT : 0,225 kg/m

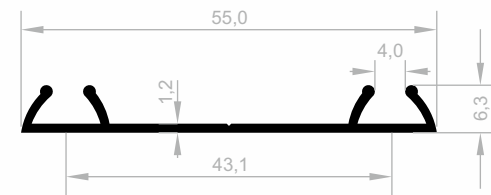

**JM 1782**  
**BODENSCHIENE**  
GEWICHT : 0,255 kg/m

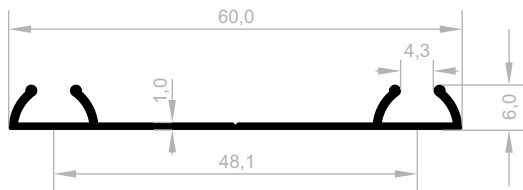

**JM 1606**  
**BODENSCHIENE**  
GEWICHT : 0,238 kg/m

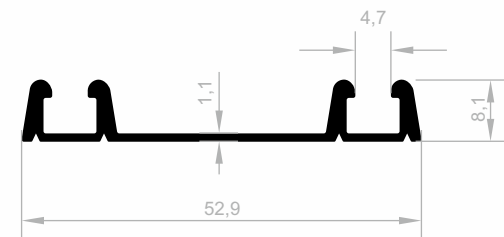

**JM 10032**  
**BODENSCHIENE**  
GEWICHT : 0,339 kg/m



## Aluminium Schiebesystem Profile

Abmessungen Höhen Profil: 2500 mm - 3000 mm - 5000 mm - 6000 mm

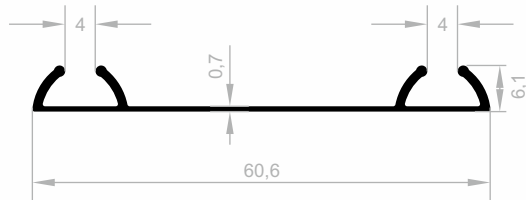

**JM 3472**  
**BODENSCHIENE**  
GEWICHT : 0,200 kg/m

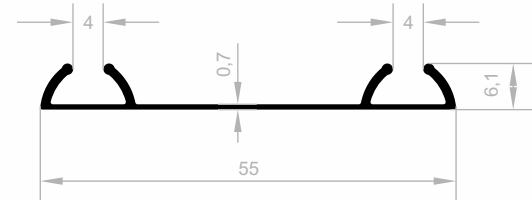

**JM 3473**  
**BODENSCHIENE**  
GEWICHT : 0,189 kg/m

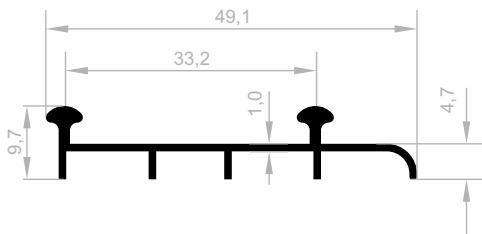

**JM 1596**  
**DECKENSCHIENE**  
GEWICHT : 0,247 kg/m

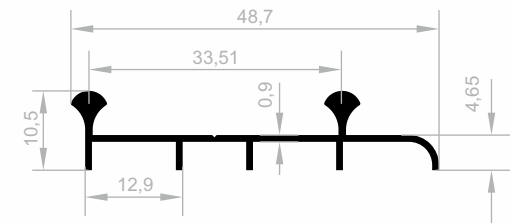

**JM 1220**  
**DECKENSCHIENE**  
GEWICHT : 0,233 kg/m

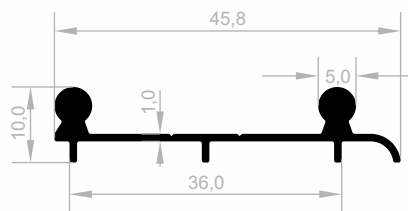

**JM 1714**  
**DECKENSCHIENE**  
GEWICHT : 0,285 kg/m

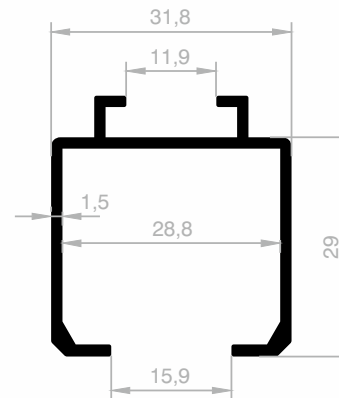

**JM 1090**  
**OBERE TÜRSCHIENE**  
GEWICHT : 0,470 kg/m

## Aluminium Schiebesystem Profile

Abmessungen Höhen Profil: 2500 mm - 3000 mm - 5000 mm - 6000 mm

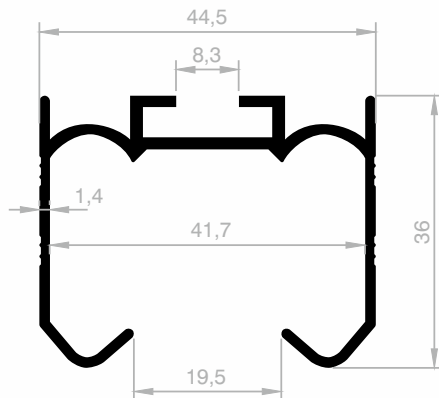

**JM 3896**  
**OBERE TÜRSCHIENE**  
 GEWICHT : 0,608 kg/m

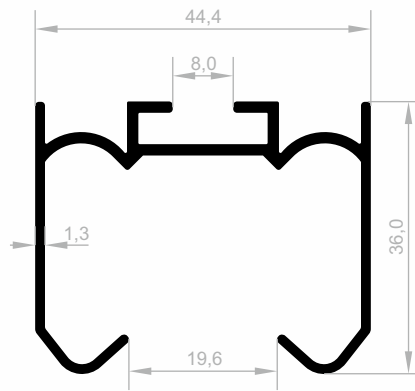

**NEU**

**JM 8753**  
**OBERE TÜRSCHIENE**  
 GEWICHT : 0,598 kg/m

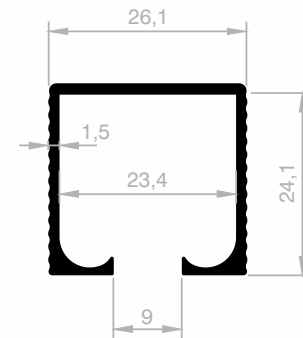

**JM 5016**  
**OBERE TÜRSCHIENE**  
 GEWICHT : 0,354 kg/m

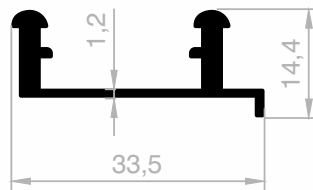

**JM 4748**  
**DECKENSCHIENE**  
 GEWICHT : 0,312 kg/m

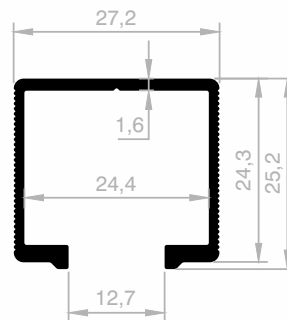

**JM 4098**  
**DECKENSCHIENE**  
 GEWICHT : 0,355 kg/m

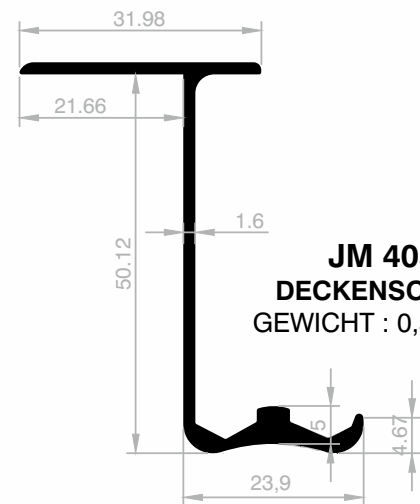

**JM 4052**  
**DECKENSCHIENE**  
 GEWICHT : 0,534 kg/m

## Aluminium Schiebesystem Profile

Abmessungen Höhen Profil: 2500 mm - 3000 mm - 5000 mm - 6000 mm

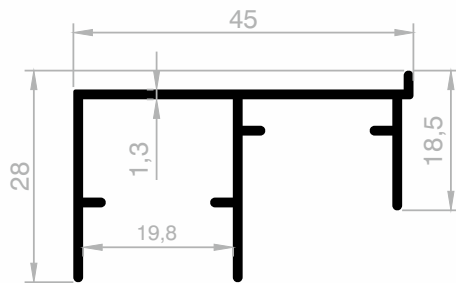

**JM 4747**  
**BODENSCHIENE**  
 GEWICHT : 0,433 kg/m

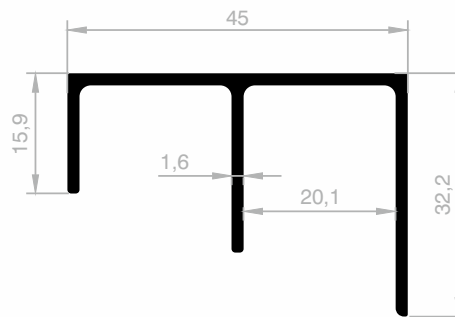

**JM 3618**  
**BODENSCHIENE**  
 GEWICHT : 0,494 kg/m

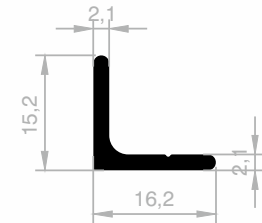

**JM 4099**  
**BODENSCHIENE**  
 GEWICHT : 0,172 kg/m

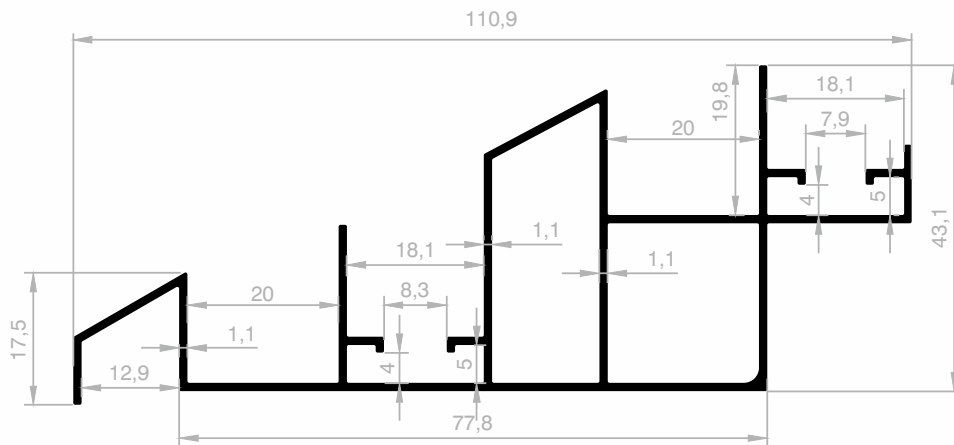

**JM 4503**  
**OBERE HÄNGESCHIENE**  
 GEWICHT : 1,010 kg/m

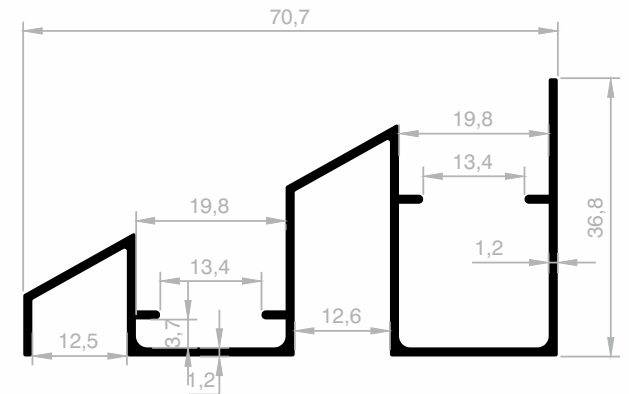

**JM 4123**  
**OBERE HÄNGESCHIENE**  
 GEWICHT : 0,645 kg/m

## Aluminium Schiebesystem Profile

Abmessungen Höhen Profil: 2500 mm - 3000 mm - 5000 mm - 6000 mm

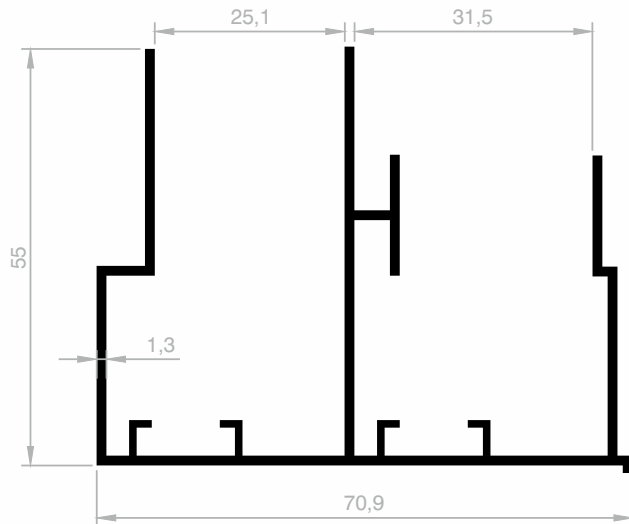

**JM 4611**  
**OBERE HÄNGESCHIENE**  
 GEWICHT : 0,949 kg/m

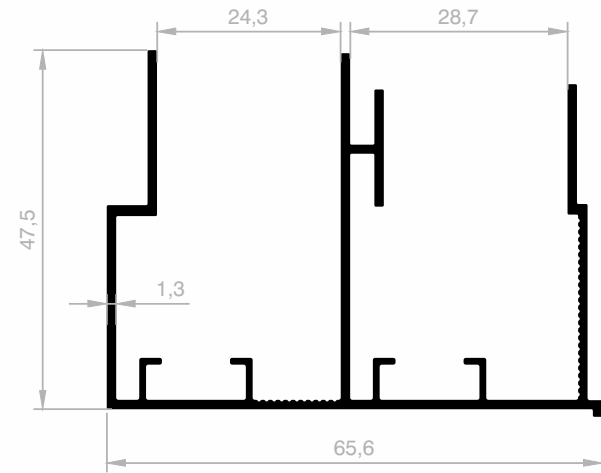

**JM 4833**  
**OBERE HÄNGESCHIENE**  
 GEWICHT : 0,835 kg/m

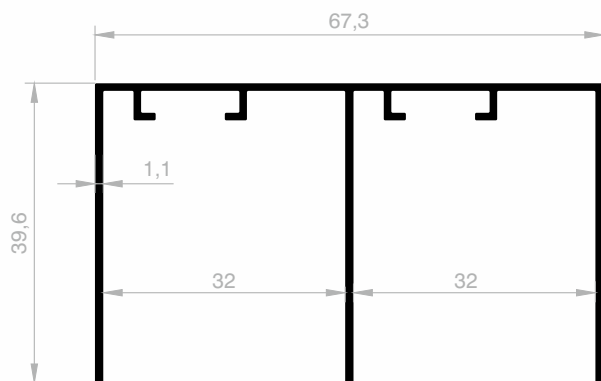

**JM 5640**  
**DECKENSCHIENE**  
 GEWICHT : 0,591 kg/m

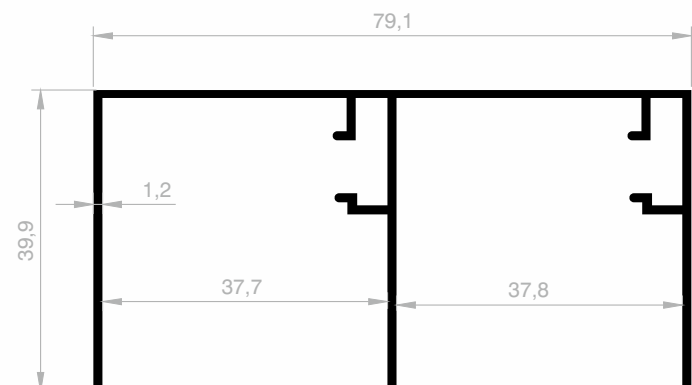

**JM 6199**  
**DECKENSCHIENE**  
 GEWICHT : 0,706 kg/m



## Aluminium Schiebesystem Profile

Abmessungen Höhen Profil: 2500 mm - 3000 mm - 5000 mm - 6000 mm

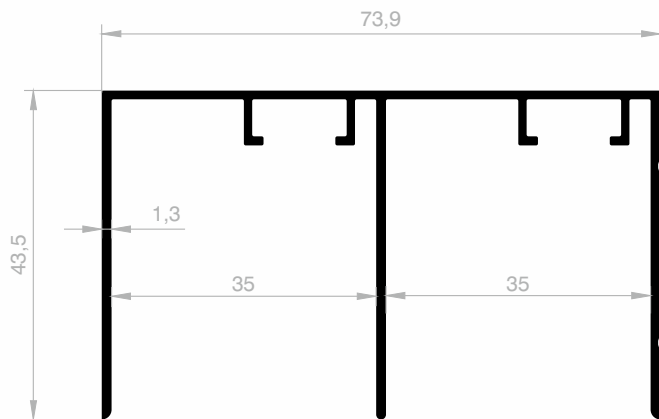

**JM 5707**  
**DECKENSCHIENE**  
GEWICHT : 0,765 kg/m

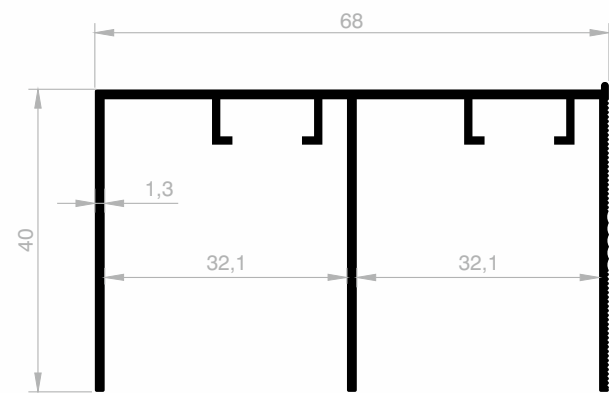

**JM 5859**  
**DECKENSCHIENE**  
GEWICHT : 0,722 kg/m

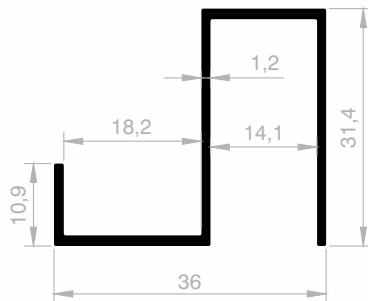

**JM 4092**  
**UNTEN DECKENSCHIENE**  
GEWICHT : 0,388 kg/m

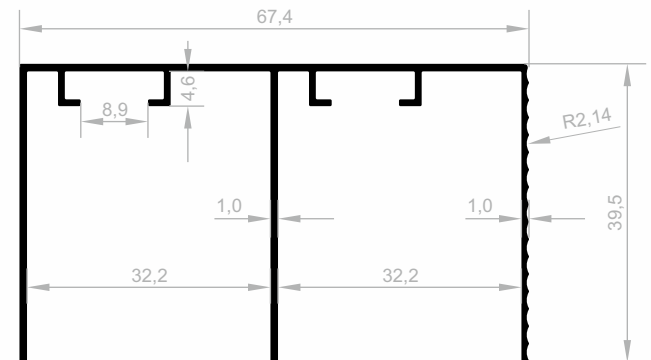

**JM 8602**  
**DECKENSCHIENE**  
GEWICHT : 0,539 kg/m



## Aluminium Schiebesystem Profile

Abmessungen Höhen Profil: 2500 mm - 3000 mm - 5000 mm - 6000 mm

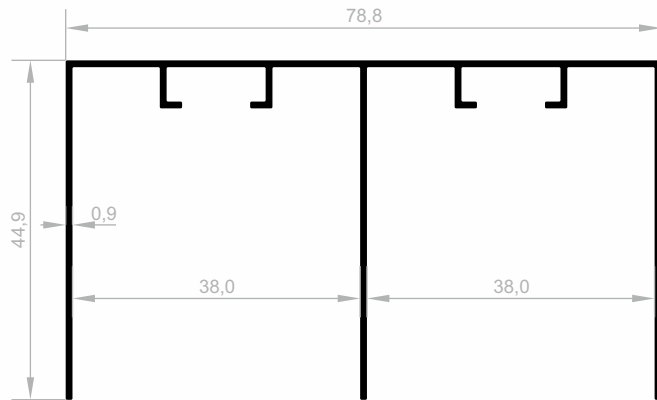

**JM 8605**  
**DECKENSCHIENE**  
GEWICHT : 0,587 kg/m

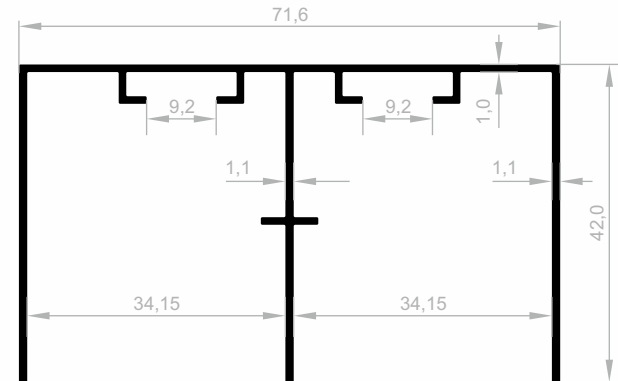

**JM 8202**  
**DECKENSCHIENE**  
GEWICHT : 0,653 kg/m

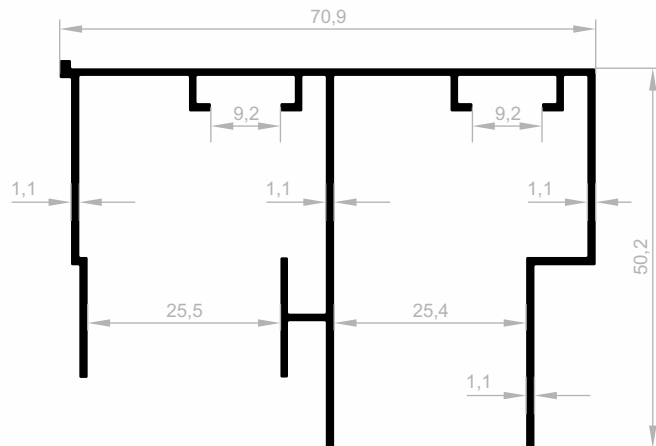

**JM 8203**  
**DECKENSCHIENE**  
GEWICHT : 0,767 kg/m

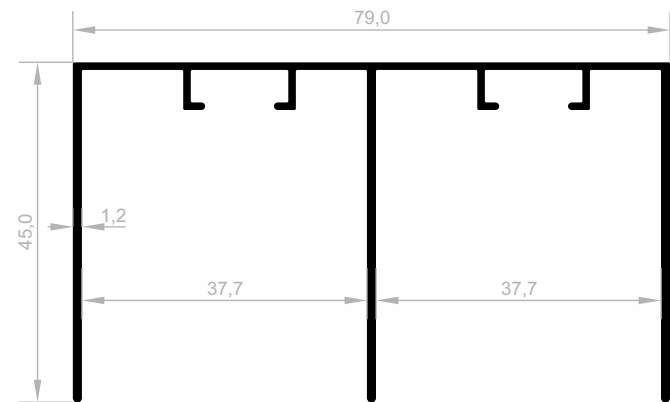

**JM 8601**  
**DECKENSCHIENE**  
GEWICHT : 0,718 kg/m

## Aluminium Schiebesystem Profile

Abmessungen Höhen Profil: 2500 mm - 3000 mm - 5000 mm - 6000 mm

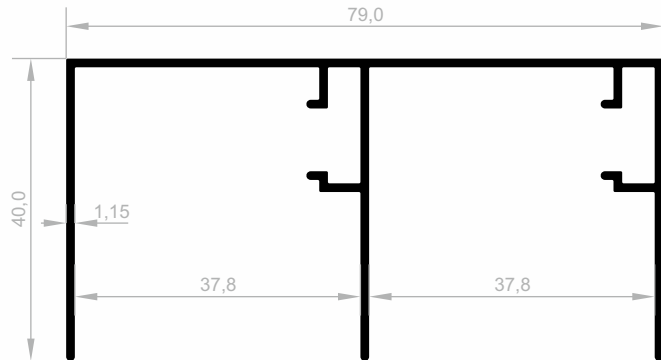

**JM 8278**  
**DECKENSCHIENE**  
 GEWICHT : 0,706 kg/m

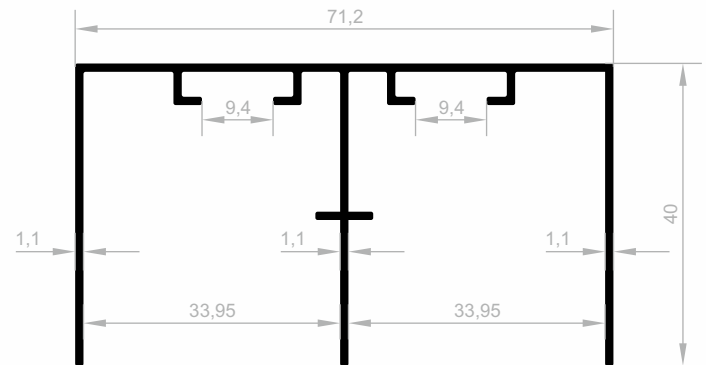

**JM 3394**  
**DECKENSCHIENE**  
 GEWICHT : 0,664 kg/m

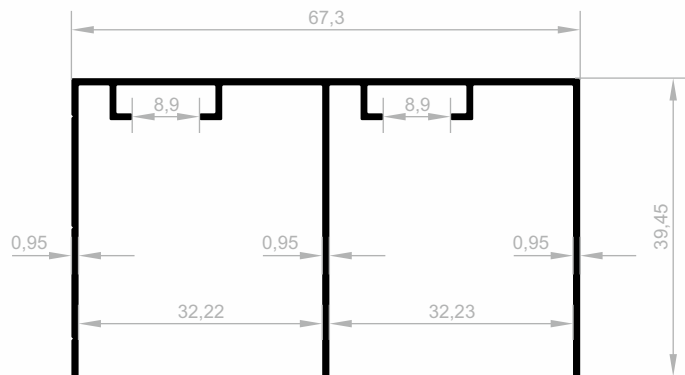

**JM 8881**  
**DECKENSCHIENE**  
 GEWICHT : 0,536 kg/m

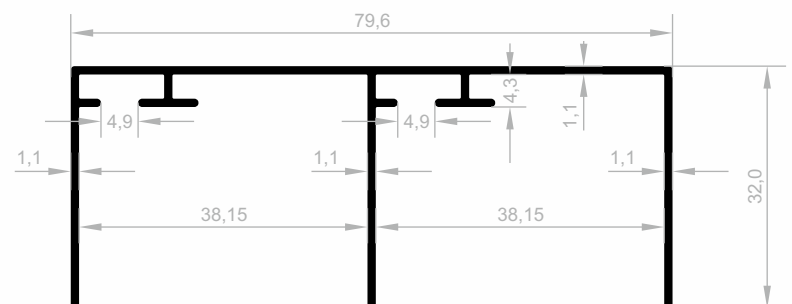

**JM 8612**  
**DECKENSCHIENE**  
 GEWICHT : 0,593 kg/m



## Aluminium Schiebesystem Profile

Abmessungen Höhen Profil: 2500 mm - 3000 mm - 5000 mm - 6000 mm

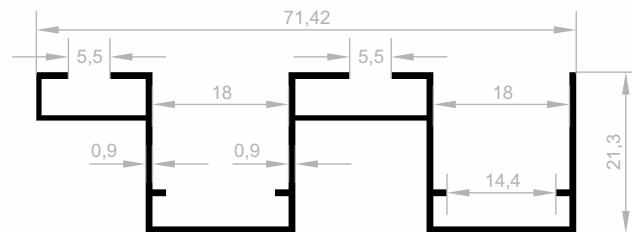

**JM 8791**  
**DECKENSCHIENE**  
GEWICHT : 0,433 kg/m



***Ihr Lösungspartner für Aluminiumprofile mit seiner hochmodernen Produktionsinfrastruktur.***

## **Soziale Medien**

Mit den Technologien, die wir ständig weiterentwickeln, Unsere Sozial-Medien-Konten, um über unsere Qualität und innovativen Aluminiumprofildesigns informiert zu sein Bitte folgen Sie.

   jutesanaluminyum

 JutesanAlmnm

 company/jutesan-alüminyum

 info@jutesanaluminyum.com.tr

 jutesanaluminyum.com.tr

